

**MULTIFUNCTIONAL DIGITAL COLOR SYSTEMS /
MULTIFUNCTIONAL DIGITAL SYSTEMS**

Copying Guide

e-STUDIO2010AC/2510AC

e-STUDIO2515AC/3015AC/3515AC/4515AC/5015AC

e-STUDIO2518A/3018A/3518A/4518A/5018A

e-STUDIO5516AC/6516AC/7516AC

e-STUDIO5518A/6518A/7518A/8518A

Preface

Thank you for purchasing TOSHIBA Multifunctional Digital Systems or Multifunctional Digital Color Systems. This manual describes how to use the copying functions of this equipment. Read this manual before using the functions.

■ How to read this manual

□ Symbols in this manual

In this manual, some important items are described with the symbols shown below. Be sure to read these items before using this equipment.

⚠ WARNING Indicates a potentially hazardous situation which, if not avoided, could result in death, serious injury, or serious damage, or fire in the equipment or surrounding objects.

⚠ CAUTION Indicates a potentially hazardous situation which, if not avoided, may result in minor or moderate injury, partial damage to the equipment or surrounding objects, or loss of data.

Note Indicates information to which you should pay attention when operating the equipment.

Tip Describes handy information that is useful to know when operating the equipment.

 Pages describing items related to what you are currently doing. See these pages as required.

□ Description of original/paper direction

Paper or originals of A4, B5 or LT size can be placed either in a portrait direction or in a landscape direction. In this manual, “-R” is added to this paper size when this size of paper or original is placed in a landscape direction.

e.g.) A4 size original on the original glass

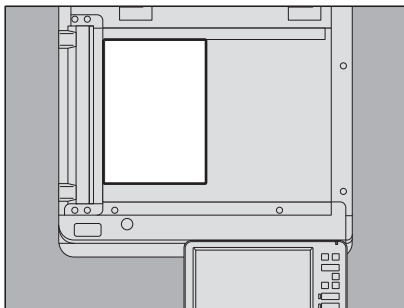

Placed in a portrait direction: A4

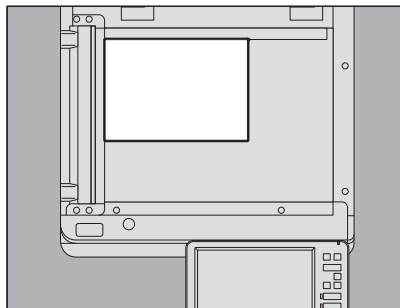

Placed in a landscape direction: A4-R

Paper or originals of A3, B4, LD or LG can only be placed in a landscape direction, therefore “-R” is not added to these sizes.

❑ Model and series names in this manual

In this manual, each model name is replaced with a series name as shown below:

Model name	Series name
e-STUDIO2010AC/2510AC	e-STUDIO5015AC Series
e-STUDIO2515AC/3015AC/3515AC/4515AC/5015AC	
e-STUDIO2018A/2518A/3018A/3518A/4518A/5018A	e-STUDIO5018A Series
e-STUDIO5516AC/6516AC/7516AC	e-STUDIO7516AC Series
e-STUDIO5518A/6518A/7518A/8518A	e-STUDIO8518A Series

❑ Optional equipment

For the available options, refer to the **Quick Start Guide**.

❑ Screens in this manual

- The details on the screens may differ depending on your model and how the equipment is used, such as the status of the installed options, the OS version and the applications.
- The illustration screens used in this manual are for paper in the A/B format. If you use paper in the LT format, the display or the order of buttons in the illustrations may differ from that of your equipment.

❑ Abbreviations in this manual

In this manual, “Dual Scan Document Feeder”(DSDF) and “Reversing Automatic Document Feeder”(RADF) are collectively referred to as “Automatic Document Feeder”(ADF).

❑ Trademarks

For trademarks, refer to the **Safety Information**.

CONTENTS

Preface	3
How to read this manual	3

Chapter 1 BEFORE MAKING COPIES

Important Information on Making Copies	10
Storage of color copies (Color Model only)	10
Forgery prevention function	10
Simple Copy	10
Basic Menu of the Copier Function	11
Equipment status indication area.....	13
Before Using Copier Functions	15
Default settings	15
Confirming the set functions.....	16
Clearing the set functions.....	17
Restrictions on function combinations	17

Chapter 2 HOW TO MAKE COPIES

Basic Copying Procedure	21
Stopping and restarting copying	23
Scanning the next original during copying (auto job start)	23
Interrupting copying and making other copies (interrupt copying)	24
Making one copy as a sample (proof copy)	25
Specifying the orientation of originals	26
Specifying the Paper Size	27
Automatic Paper Selection (APS)	27
Selecting the drawer for your desired paper manually	28
Copying mixed-size originals in one operation	29
Specifying the Paper Type	31
Copying onto recycled paper, thick paper	31
Copying onto thin paper, sticker labels, or special paper	31
Specifying and copying cover sheets or paper to insert	31
Bypass Copying	32
Bypass copying on standard size paper	33
Bypass copying on non-standard size paper.....	38
Selecting Exit Tray	40
Changing the exit tray.....	40
Switching Color Modes (Color Model only)	41
Adjusting Density	42
Adjusting automatically (automatic density adjustment).....	42
Adjusting manually	42
Enlarging or Reducing Images	43
Automatic Magnification Selection (AMS)	44
Specifying both the original size and the copy paper size separately	45
Specifying reproduction ratio manually.....	48
Copying photo originals in the optimal reproduction ratio for copy paper size (Photo Zoom) (Color Model only).....	49
Reducing images to scan the entire original, including the edges (Full Image) (Color Model only).....	52
Reducing and Centering an Image (Centering Copy).....	53
Selecting Finishing Mode	54

Finishing modes and optional finishing devices	54
Sort and group mode	55
Rotate sort mode	56
Staple sort mode	57
Magazine sort / Center fold / Saddle stitch	58
Hole punch mode	61
Duplex Copying	62
Making a 1-sided copy	63
Making a 2-sided copy	64
Making a 2-sided copy from a book-type original	65
Setting Original Modes	68

Chapter 3 HOW TO USE EDITING FUNCTIONS

Displaying the Edit Menu	70
Creating Margins	71
Creating top, bottom, left, and right margins	71
Creating bookbinding margins	73
Copying Multiple Originals onto One Sheet (2 in 1 / 4 in 1)	74
Applying Different Settings for Cover Sheets (Cover Sheet)	77
Inserting a Sheet at a Desired Page (Sheet Insertion)	79
Adding a Date and Time on Copied Paper	82
Adding a Page Number on Copied Paper (Page Number)	83
Editing Scanned Images	84
Trimming and masking	84
Mirror image and negative/positive reversal	87
Applying Separate Reproduction Ratios to Vertical and Horizontal Directions (XY Zoom)	88
Copying the Same Image Repeatedly on One Sheet (Image Repeat) (Color Model only)	89
Removing Blank Pages While Copying (Omit Blank Page)	91
Clearing Dirty Edges of Originals (Edge Erase)	92
Clearing Shadows in the Center of Book-type Originals (Book Center Erase)	93
Copying the Sides of Book-type Originals Separately (Dual Page)	95
Clearing Dark Parts Outside the Originals (Outside Erase)	97
Applying Multiple Settings (Job Build)	99
Switching Feeding Modes (ADF -> SADF)	102
Reducing Images to Scan the Entire Original, Including the Edges (Full Image)	103
Centering a Scanned Image (Centering Copy)	104

Chapter 4 USING IMAGE ADJUSTMENT FUNCTIONS

Displaying the Image Menu	106
Adjusting Color Balance (CMYK adjustment) (Color Model only)	107
Canceling color balance adjustment	107
Adjusting RGB (Color Model only)	108
Canceling RGB adjustment	108

Adjusting the Image Quality with One Touch (Color Model only)	109
Canceling one-touch adjustment	109
Avoiding Bleed-through (Background adjustment)	110
Canceling background adjustment.....	110
Adjusting the Sharpness	111
Canceling sharpness adjustment.....	111
Applying Twin Color Copying (Color Model only)	112
Copying in black and specified color	112
Copying in red and black.....	115
Applying Mono Color Copying (Color Model only)	117
Canceling mono color copying.....	117
Adjusting the Hue (Color Model only)	118
Canceling hue adjustment	118
Adjusting the Saturation (Color Model only)	119
Canceling saturation adjustment	119
Reducing the Scan Noise	120
Canceling the ADF scan noise reduction	120
Copying black images only (Color Model only)	121

Chapter 5 SAVING COPIED DATA AS A FILE

Copying and Saving as a File	124
Setting share folder	126
INDEX	129

BEFORE MAKING COPIES

This chapter explains what you should know before making copies and the content of the Basic menu screen.

Important Information on Making Copies	10
Storage of color copies (Color Model only)	10
Forgery prevention function	10
Simple Copy	10
Basic Menu of the Copier Function	11
Equipment status indication area.....	13
Before Using Copier Functions.....	15
Default settings	15
Confirming the set functions.....	16
Clearing the set functions.....	17
Restrictions on function combinations	17

Important Information on Making Copies

■ Storage of color copies (Color Model only)

When storing color copies, be careful of the following:

- Avoid a place exposed to light. The colors may fade when they are stored in such a place for a long time.
- If copies are stored pressed between plastic sheets made of chloroethylene for a long time, toner may melt and stick to the plastic. For long-time storage, use polyethylene binders.
- When a color copy is folded, toner at the folded part may flake off. Do not fold color copies when storing them.
- Toner on copies may melt if it touches solvent or ink not fully dried. Keep copies away from them.
- When copies are left under an extremely high temperature environment such as in the vicinity of a heater, toner may melt. Store them at room temperature and avoid extreme temperature changes.

■ Forgery prevention function

This equipment has a forgery prevention function. Therefore, scan or copy function might not operate correctly.

■ Simple Copy

The equipment provides an independent menu called “Simple Copy” so that you can make copies with minimum operations.

To learn how to use the menu, refer to the **Quick Start Guide** of this equipment.

Basic Menu of the Copier Function

The Basic menu for the copier function shows the following information:

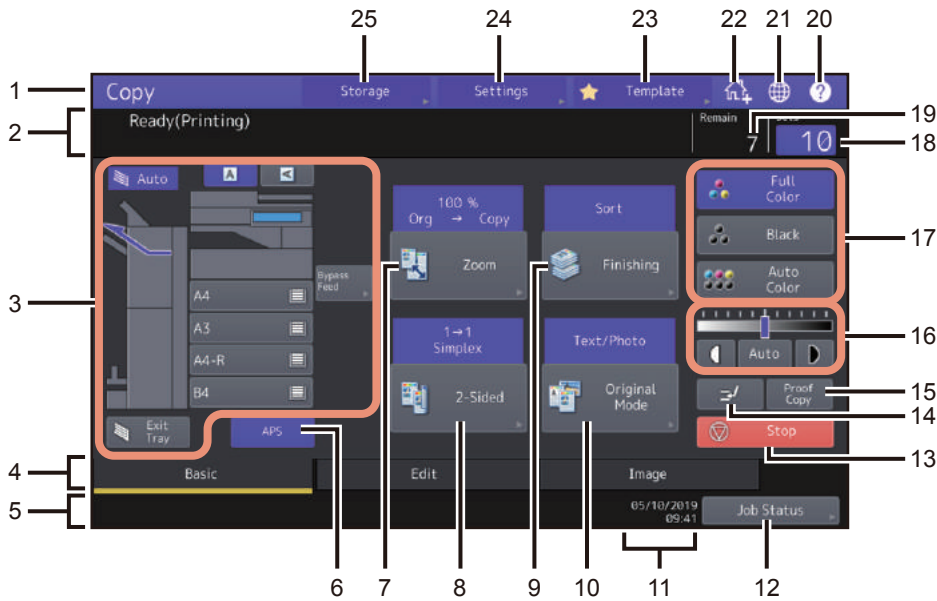

- 1. Function display**
The function being used, such as copying, is displayed.
- 2. Message indication area**
This shows a brief description of the functions or the current status of this equipment in message form.
- 3. Equipment status indication area (📄 P.13)**
This shows the size, paper type or amount of paper remaining in each drawer.
- 4. Index tabs (Basic, Edit, Image)**
These are for switching between the menus of “Basic”, “Edit” and “Image”.
- 5. Alert message indication area**
This shows alert messages such as the replacement timing of the toner cartridges or the waste toner box.
- 6. [APS] (automatic paper selection) button (📄 P.27)**
This is for changing the mode to automatic paper selection.
- 7. [Zoom] button (📄 P.43)**
This is for changing the reproduction ratio of images.
- 8. [2-Sided] button (📄 P.62)**
This is for selecting simplex/duplex copying (e.g. 1 -> 2-sided, 2 -> 2-sided).
- 9. [Finishing] button (📄 P.54)**
This is for selecting a sorting mode.
- 10. [Original Mode] button (📄 P.68)**
This is for selecting an original mode.
- 11. Date and time**

-
12. **[Job Status] button**
This is for confirming the processing status of copy, fax, scan or print jobs, and also for viewing their performing history. Pressing [Job Status] > [Jobs] > [Scan] displays the scan job statuses in list.
For more instructions on viewing job statuses, refer to the **Software Troubleshooting Guide**.
 13. **[Stop] button** (📄 P.23)
This is to stop making copies.
 14. **Interrupt copying button** (📄 P.24)
This is for interrupting the copy job in progress to make other copies.
 15. **[Proof Copy] button** (📄 P.25)
This is for making a proof copy to check an image before making a large amount of copies.
 16. **Density adjustment buttons** (📄 P.42)
These are for adjusting the density level of images.
 17. **Color mode buttons** (📄 P.41)
These are for switching color modes.
 18. **Number of copy sets**
This shows the number of copies to be made. To change it, press this area and enter the desired number.
 19. **Number of remaining copy sets**
 20. **[?](Help) button**
This is for viewing the explanation of each function or the buttons on the touch panel.
 21. **Language button**
This is to switch a language.
 22. **Adding to Home screen button**
This is to add a setting such as a job setting to the Home screen. For more instructions, refer to the **Template Guide**.
 23. **[Template] button**
This is for the template function. For more details, refer to the **Template Guide**.
 24. **[Settings] button** (📄 P.16)
This is for checking currently set functions.
 25. **[Storage] button** (📄 P.124)
This is for the storage function.

When this equipment is managed with the user management function and department management function

In the above case, the job quota assigned to each user or department appears in the alert message indication area for approx. 5 seconds after user authentication.

The displayed number is the smaller one of either user (👤) or department (👥).

Tip

- The display may differ depending on the management status of this equipment.
- For details of the user management function or the department management function, ask your administrator.

■ Equipment status indication area

The equipment status indication area shows the following information:

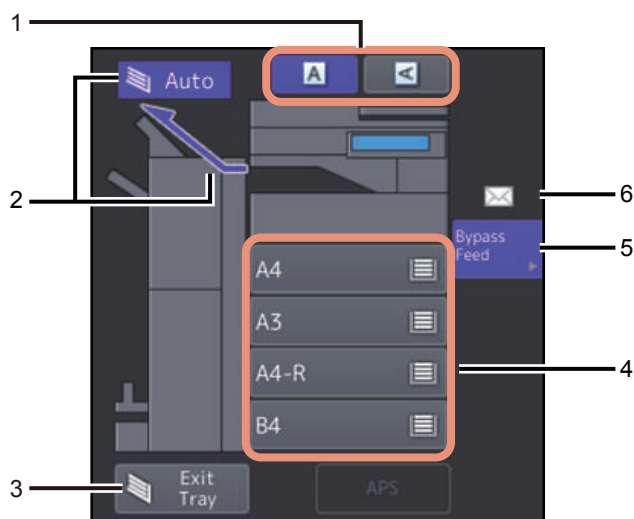



1. **Paper direction button** (📄 P.26)
This is for setting the orientation of an original.
2. **Receiving tray indication** (📄 P.40)
This shows the tray to which copied paper exits.
3. **[Exit Tray] button** (📄 P.40)
This is for switching receiving (exit) trays.
4. **Drawer buttons** (📄 P.28)
These show the size of paper, amount of paper remaining in each drawer and the paper type set for the drawer. To learn how to place paper in the drawers and the meanings of the icons displayed, refer to the **Paper Preparation Guide**.
When you want to use a particular drawer, press the corresponding button.

Note

If a size other than the one for the paper you have set or “⚠️---” appears, the paper size detection has failed. If this is the case, refer to the **Hardware Troubleshooting Guide**.

Tip

e-STUDIO2010AC/2510AC: The amount of paper remaining in the standard drawer (first drawer) is displayed as follows.

Drawer status	Display
Placed	
No paper	

5. **[Bypass Feed] button** ( P.32)

When this button is pressed with paper set on the bypass tray, it will be selected as the paper source.

6. **Paper type on the bypass tray**

This shows the type of paper placed on the bypass tray with an icon. To learn how to place paper in the drawers and the meanings of the icons displayed, refer to the ***Paper Preparation Guide***.

Before Using Copier Functions

■ Default settings

This equipment is under its “default settings” when the power is turned ON, namely, if no setting change has been applied yet, the equipment’s settings return to the default ones when the energy saving mode is cleared or the [FUNCTION CLEAR] button on the control panel is pressed. The default settings for basic copy modes at installation are shown below.

Item	Default setting
Reproduction ratio	100%
Copy quantity	1
Paper selection	Automatic Paper Selection (APS)
Simplex/Duplex	1-sided original -> 1-sided copy
Density adjustment	Manual adjustment
Color mode	Full Color
Original mode	Text/Photo
Finishing mode	When using the original glass: Non-Sort Non-Staple When using the ADF: Sort
Feeding mode when using the ADF	Continuous feed mode

The default settings are changeable. For details, refer to the **MFP Management Guide**.

■ Confirming the set functions

If you press [Settings] on the touch panel, the menu shown below is displayed. On this menu, you can view the functions that are currently set.

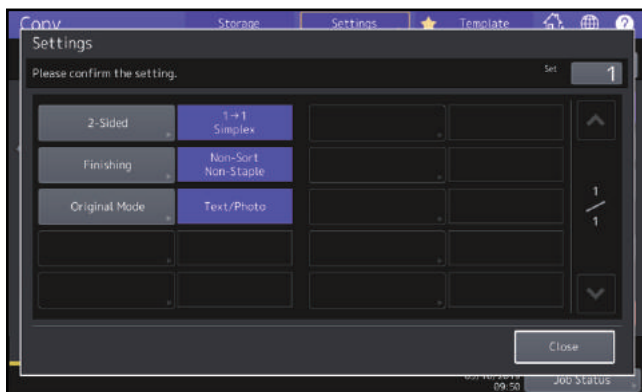
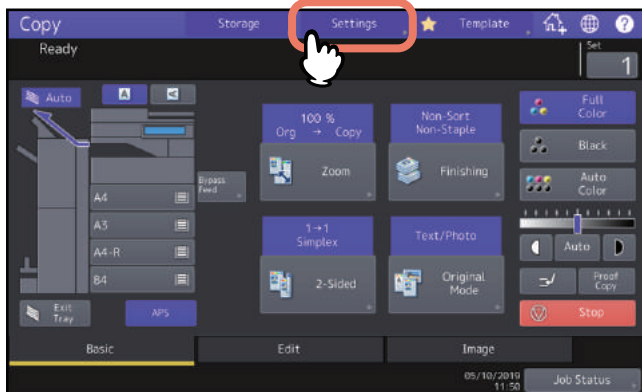

Switching to the function setting menu

To change the functions on the current menu, press the corresponding buttons. The desired setting menu will then appear.

■ Clearing the set functions

If you want to clear any copy function setting, press [Reset] on the corresponding setting menu.

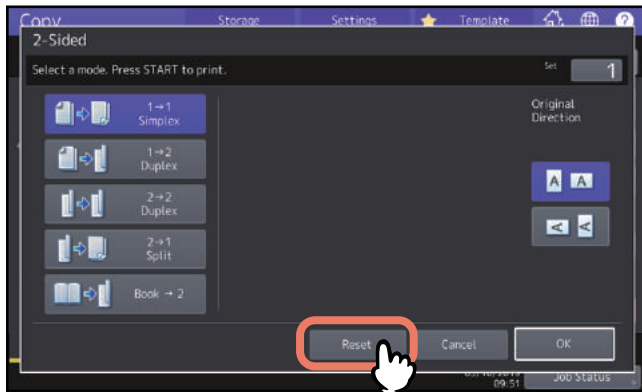

However, for Full Image on the Edit menu, also press the highlighted button to clear the setting.

📖 P.70 "Displaying the Edit Menu"

❑ Clearing all settings changed

When you press the [FUNCTION CLEAR] button on the control panel, all the function changes will be cleared.

Even if you do not do so, the changes will be cleared if the equipment is left idle for 45 sec. (default setting). For how to change this period, refer to the *MFP Management Guide*.

■ Restrictions on function combinations

Several copy functions can be used together. However some functions may not be used with other ones.

HOW TO MAKE COPIES

This chapter explains the basic copying procedures.

Basic Copying Procedure	21
Stopping and restarting copying	23
Scanning the next original during copying (auto job start)	23
Interrupting copying and making other copies (interrupt copying)	24
Making one copy as a sample (proof copy)	25
Specifying the orientation of originals	26
Specifying the Paper Size	27
Automatic Paper Selection (APS)	27
Selecting the drawer for your desired paper manually	28
Copying mixed-size originals in one operation	29
Specifying the Paper Type	31
Copying onto recycled paper, thick paper	31
Copying onto thin paper, sticker labels, or special paper	31
Specifying and copying cover sheets or paper to insert	31
Bypass Copying	32
Bypass copying on standard size paper	33
Bypass copying on non-standard size paper	38
Selecting Exit Tray	40
Changing the exit tray	40
Switching Color Modes (Color Model only)	41
Adjusting Density	42
Adjusting automatically (automatic density adjustment)	42
Adjusting manually	42
Enlarging or Reducing Images	43
Automatic Magnification Selection (AMS)	44
Specifying both the original size and the copy paper size separately	45
Specifying reproduction ratio manually	48
Copying photo originals in the optimal reproduction ratio for copy paper size (Photo Zoom) (Color Model only)	49
Reducing images to scan the entire original, including the edges (Full Image) (Color Model only)	52
Reducing and Centering an Image (Centering Copy)	53
Selecting Finishing Mode	54
Finishing modes and optional finishing devices	54
Sort and group mode	55
Rotate sort mode	56

Staple sort mode.....	57
Magazine sort / Center fold / Saddle stitch.....	58
Hole punch mode.....	61
Duplex Copying	62
Making a 1-sided copy	63
Making a 2-sided copy	64
Making a 2-sided copy from a book-type original.....	65
Setting Original Modes.....	68

Basic Copying Procedure

Make copies following the procedure below.

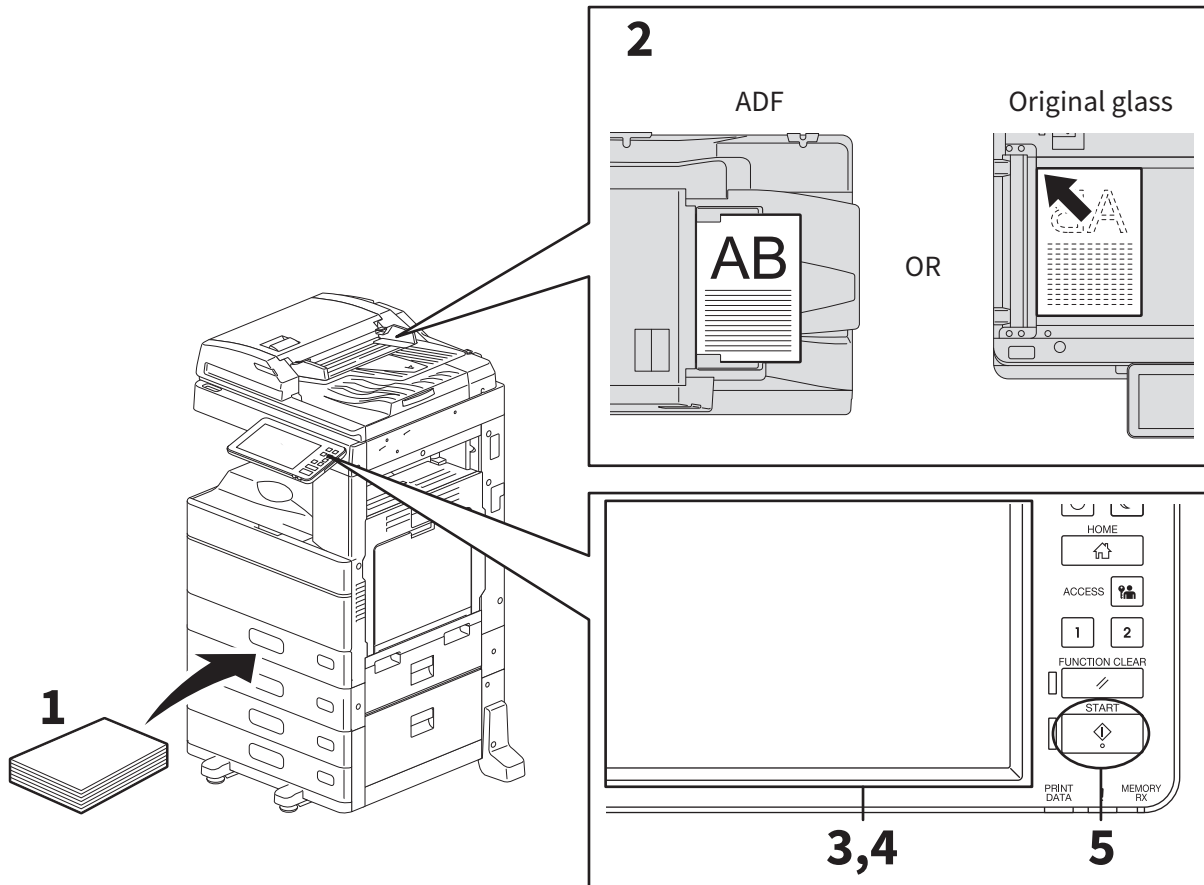

- 1 Make sure that paper is placed in the drawer(s).**
For the types and sizes of acceptable paper and how to place it, refer to the *Paper Preparation Guide*.
- 2 Place the original(s).**
For the types and sizes of originals and how to place them, refer to the *Paper Preparation Guide*.
- 3 Enter the desired number of copies on the touch panel if you want more than one copy.**
- 4 Select the copy modes as required.**
- 5 Press the [START] button on the control panel.**
Copying starts. The paper exits with its copied side down.

Note

Be careful because the paper exiting area and the paper itself are hot.

The menu shown below may appear when you are using particular modes.

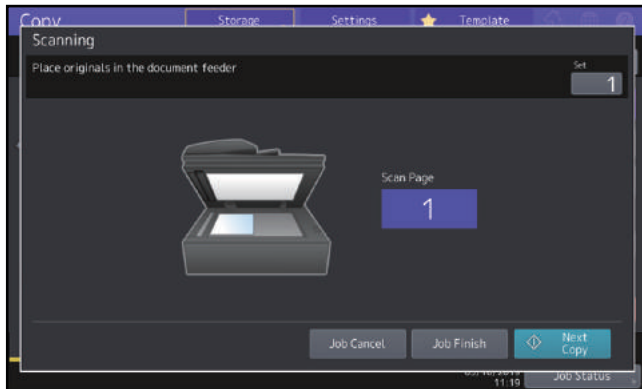

This menu appears when “SADF (single feed mode)” is set to the document feeder or in modes where the original is placed on the original glass and the scanned data are temporarily stored in the memory, such as sort copying or 1-sided to 2-sided copying. When this menu appears, follow the procedure below.

Tip

There are different messages displayed on the upper part of the menu for when the originals are scanned through the ADF and for when scanning is performed through the original glass.

6 Place the next original, and then press the [START] button on the control panel or [Next Copy] on the touch panel.

Scanning starts. (When “SADF (single feed mode)” is set to the document feeder, an original is fed automatically when it is placed on the ADF.)

7 Press [Job Finish] on the touch panel after all the originals have been scanned.

Copying starts.

Tip

If you want to stop copying, press [Job Cancel].

■ Stopping and restarting copying

- 1 Press [Stop] on the touch panel.
Copying or scanning stops.
- 2 Press [Job Cancel] on the touch panel to stop copying.
Press [Next Copy] on the touch panel or the [START] button on the control panel to restart.

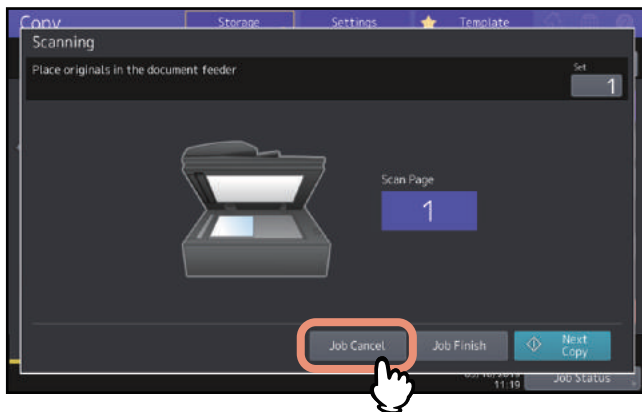

When you press [Job Cancel], the scanned data will be deleted and any waiting jobs will be performed.

Tip

Even if you do not press [Job Cancel], the scanned data will be deleted by means of the automatic function clear.

■ Scanning the next original during copying (auto job start)

Even if copying is in progress or “Ready (Warming Up)” is displayed on the touch panel, you can scan the next original (auto job start).

- 1 Set the number of copy sets and the copy modes as required.

Note

The new job starts in the copy modes that you previously selected unless you select other modes.

- 2 Press the [START] button on the control panel.

Tip

A maximum of 1000 sheets can be scanned per 1 copy job or up until the embedded memory becomes full.

Confirming auto jobs

You can confirm which jobs are in waiting on the touch panel or cancel them as required. For details, refer to the *Software Troubleshooting Guide*.

Canceling jobs being scanned

Press [Stop] on the touch panel to stop a job while originals are being scanned. When you press [Job Cancel] on the touch panel or the [FUNCTION CLEAR] button on the control panel while the scanning is being paused, the scanning will end. (In this case, the data which were scanned before the job was paused will be copied.) To restart the scanning, press the [START] button.

■ Interrupting copying and making other copies (interrupt copying)

You can interrupt the copy job in progress to make other copies (interrupt copying). When restarting the interrupted job, you do not have to reselect copy modes that have been set because they are memorized in this equipment.

Note

The following functions cannot be used together with interrupt copying:

- Cover sheet copying, Sheet insertion copying, Job build, Store to e-Filing, Copy & File
- During interrupt copying, the mode cannot be changed to a non-copying one, such as e-Filing, scanning, printing or fax. To change the mode, first press  to clear the interrupt copying.
- When interrupt copying has been used in the non-copying modes and then it is cleared, the menu returns to the Basic menu of the Copier function.

1 Press .

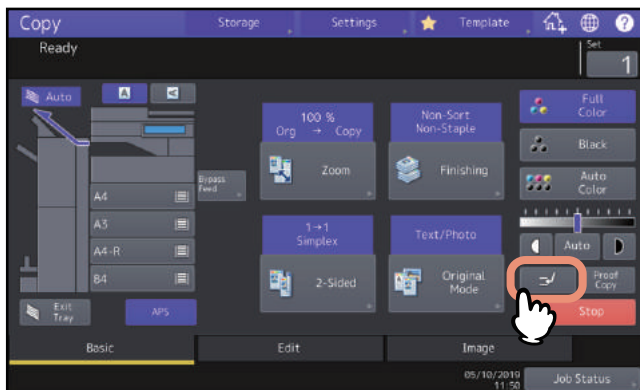

A message appears indicating that interrupt copying is ready, and “Interrupt” is displayed on the function display.

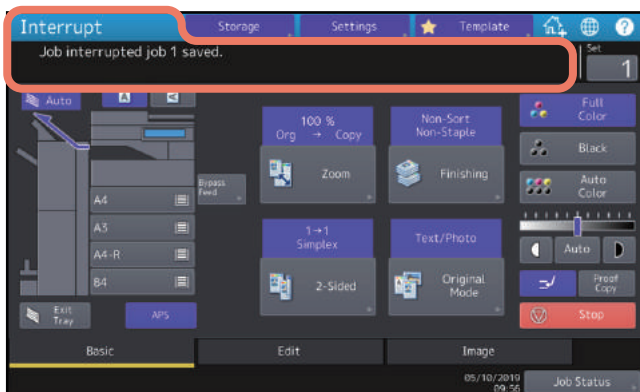

Tip

If the original is being scanned, the message above appears after the scanning has finished.

2 Select other copy modes as required and then press the [START] button on the control panel.

3 Press again after the interrupt copying has finished. The interrupted job restarts.

■ Making one copy as a sample (proof copy)

When you make a large amount of copies, you can check if they will be made exactly as you desire by copying only one set before copying them all (proof copy). Then you can change the modes or settings (e.g. the number of copy sets, receiving tray, page number, time stamp, sort, stapling, hole punching) after checking the proof copy.

Note

If you want to change settings such as the reproduction ratio, density, original mode or 1/2-sided copying, you must finish the proof copy first. Then change these settings and scan the original again.

1 Select the number of copy sets and copy modes.

2 Press [Proof Copy] on the touch panel.

A message appears for approx. 2 seconds indicating proof copy is ready.

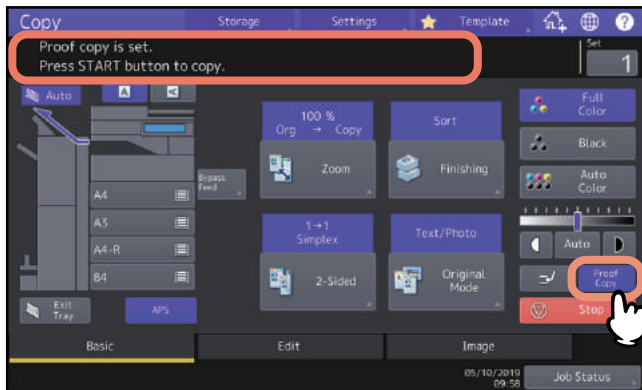

Note

If [Non-Sort Non-Staple] or [Group] is selected as a finishing mode, the mode will be changed to [Sort] automatically.

3 Press the [START] button on the control panel.

Scanning starts. 1 set of copies will be printed out.

4 Change the number of copy sets and copy modes as required after checking the proof copy.

Modes or settings such as the number of copy sets, the receiving tray, page number, time stamp, sort, stapling and punching can be changed.



5 Press the [START] button on the control panel.

If you did not change the number of copies in step 4 above, the number of copies printed out will be one fewer than that previously set because you have already copied one as a proof copy. (However, if the number of copies you previously set was 1, another set of copies will be printed out besides the proof copy.)

Specifying the orientation of originals

You can specify the orientation of the placed originals.

1 Press a paper direction button on the Basic menu, matching the orientation of the placed original.

When the placed original faces to the front (with its bottom toward you), press []. When the original faces to the side (with its bottom to the right), press [].

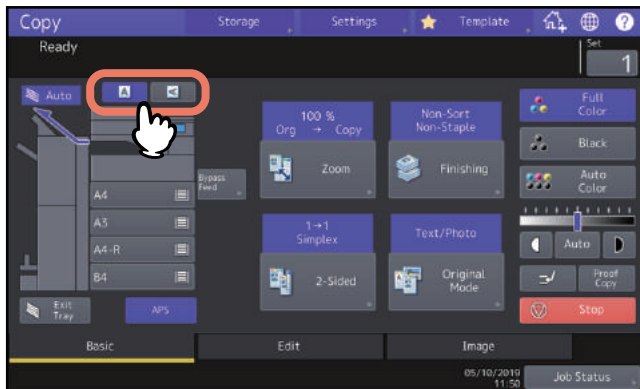

Note

This setting can be also specified in “Finishing mode” or “Duplex copying mode”.
When you change the orientation on different setting screens, the last specified setting is applied.

 P.54 “Selecting Finishing Mode”

 P.62 “Duplex Copying”

Specifying the Paper Size

The paper size is automatically detected when you place paper in the drawer(s).

Depending on the administrator's setting, you can manually change the paper size. For more details, refer to the **MFP Management Guide**.

Automatic Paper Selection (APS)

This equipment detects the size of an original and selects paper of the same size automatically.

Tip

- For the original sizes detectable, refer to the **Specifications Guide**.
- Some original sizes may not be detected with this function. In this case, select the drawer for your desired size manually.
 - P.28 “Selecting the drawer for your desired paper manually”

1 Press [APS] on the touch panel.

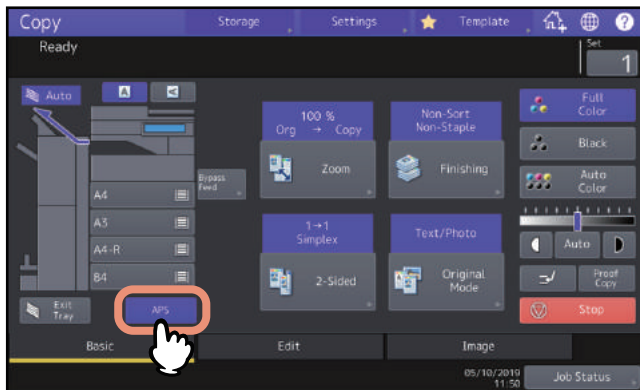

The paper selection mode is now set at Automatic Paper Selection.

Tip

- The paper selection mode is set at Automatic Paper Selection by default.
- Even if the direction of the paper placed in the selected drawer differs from that of the original, this equipment rotates the data of the original by 90 degrees to make copies as long as their sizes are the same. (This works on A4, B5 or LT paper only.) For example, when an A4 original is placed in a portrait direction and A4-R paper is placed in the drawer, the data of the A4 original will be rotated and copied correctly on A4-R paper.

Note

If “Change direction of original” or “Change Drawer to Correct Paper Size” appears, follow the directions.

2 Select other copy modes as required, and then press the [START] button on the control panel.

■ Selecting the drawer for your desired paper manually

You need to select paper by yourself when copying the following originals whose sizes cannot be detected correctly:

- Highly transparent originals (e.g. OHP film, tracing paper)
- Totally dark originals or originals with dark borders
- Non-standard size originals (e.g. newspapers, magazines)

Tip

When paper of the size you want to use is not in any drawer, place it in a drawer or on the bypass tray.

To learn how to place paper, refer to the **Paper Preparation Guide**.

📖 P.32 “Bypass Copying”

1 Press the drawer button corresponding to the desired paper size.

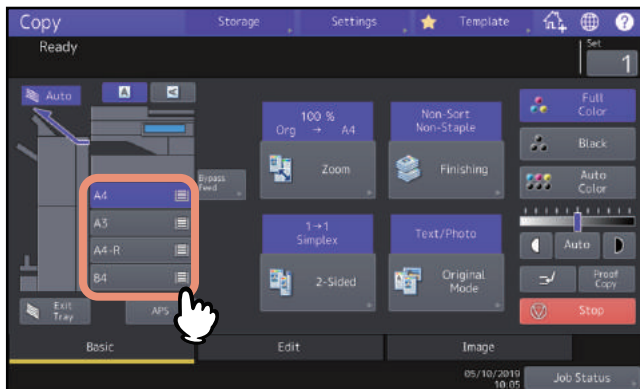

When using bypass copying, be sure to set the paper size. For instructions, refer to the **Paper Preparation Guide**.

2 Select other copy modes as required, and then press the [START] button on the control panel.

■ Copying mixed-size originals in one operation

You can copy or scan a set of originals whose sizes are individually different, using the ADF with the mixed size function.

The original sizes that can be mixed are as follows:

North America: LD, LG, LT, LT-R, COMP

Other than North America: A3, A4, A4-R, B4, B5, FOLIO

Note

- When copying mixed-size originals in one operation, the bypass tray cannot be used. Use the drawers.
- To learn how to place mixed-size originals, refer to the **Paper Preparation Guide**.

1 Press [Zoom] on the Basic menu.

2 Press [Mixed Size].

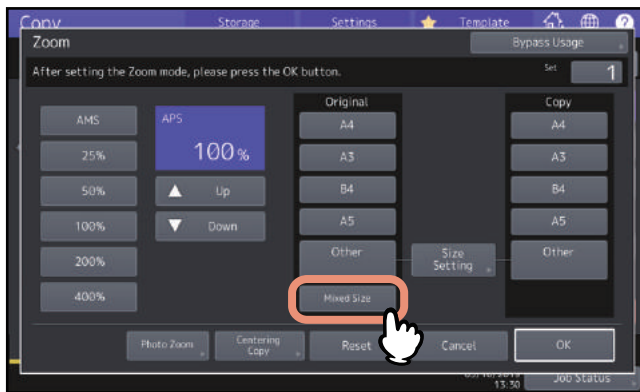

3 Select a paper size.

To make copies on paper in one size, select a paper size and then press [AMS].

To make copies on paper of the same size as the originals, press [OK] or [Cancel] so that the menu returns to the Basic menu, and then press [APS].

When [AMS] is selected:

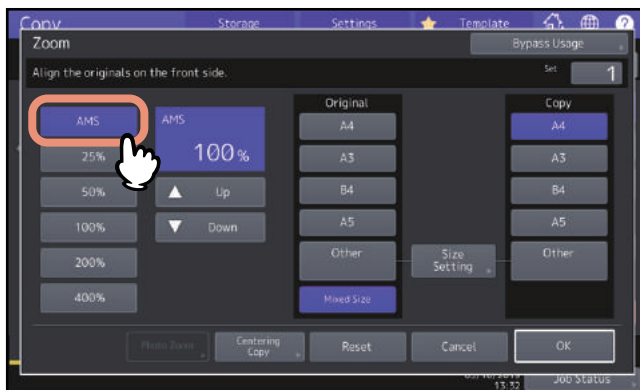

Note

- In the Automatic Magnification Selection, copy images cannot be enlarged from A4 (portrait), B5 (portrait) or LT (portrait) to A3 (landscape), B4 (landscape), LD (landscape) or LG (landscape). In this case, place A4, B5 or LT originals in a landscape direction.
- Before you use Automatic Paper Selection, be sure that all paper sizes corresponding to the original sizes have been placed in the drawers.

4 Select other copy modes as required, and then press the [START] button on the control panel.

Note

If “Change direction of original” appears while scanning is in progress, remove the original from the ADF and change its direction accordingly.

Specifying the Paper Type

When you place any special paper other than plain paper or that not used for normal copying, you need to set the thickness and attribute into this equipment.

Note

If you select a wrong paper type, this could cause a paper misfeed or significant image trouble.

■ Copying onto recycled paper, thick paper

When you place recycled paper, thick paper in the drawer, set the thickness and attribute into this equipment. To learn how to place paper and specify the paper type, refer to the **Paper Preparation Guide**.

After setting the thickness and attributes for a drawer, set it to feed paper and make copies.

 P.28 "Selecting the drawer for your desired paper manually"

■ Copying onto thin paper, sticker labels, or special paper

Thin paper, sticker labels, or special paper can be used to make copies by using the bypass tray.

 P.32 "Bypass Copying"

Place such paper on the bypass tray and set the thickness and attributes into this equipment before you start copying.

To learn how to place paper and specify the paper type, refer to the **Paper Preparation Guide**.

Supported paper types for the bypass differ depending on the model. For supported paper types, refer to the **Specifications Guide**.

■ Specifying and copying cover sheets or paper to insert

Cover sheets or paper to insert a specific page can be prepared and copied in a drawer different from an ordinary drawer. Place paper in a drawer and set attribute as the paper type. For setting for attribute, refer to the **Paper Preparation Guide**.

Bypass Copying

When you make copies on OHP film, sticker labels, envelopes, or non-standard size paper, place the copy paper on the bypass tray. Bypass copying is also recommended for copying on standard size paper which is not set in any of the drawers.

⚠ CAUTION

Be careful not to cut your fingers when fanning paper.

This could cause an injury.

Note

- The height of the paper must not exceed the indicator on the side guides.
- When you use more than one sheet of paper, fan the sheets well before placing them on the bypass tray.
- Do not push paper into the entrance of the bypass feeder. This could cause a paper misfeed.
- When you copy on sheets of OHP film, remove the copied OHP film one sheet at a time as they exit onto the receiving tray. If the sheets of OHP film pile up, they may get curled and may not be projected properly.

Tip

- If you place the originals on the ADF for bypass copying and do not set the paper size, the originals will be copied upside down. Be sure to set the paper size when you wish to do bypass copying.
To learn how to place paper on the bypass tray, refer to the **Paper Preparation Guide**.
- Bypass copying stops when the paper placed on the bypass tray runs out during copying, even if the paper of the same size is in any of the drawers. Copying restarts when paper is supplied to the bypass tray.
- When bypass copying has been completed, the [FUNCTION CLEAR] button on the control panel blinks. Press this button to switch bypass copying to normal copying using the drawers.
(Even if you do not press the [FUNCTION CLEAR] button, the bypass copying mode will be cleared when the automatic function clear mode kicks in after a specified period of time.)
- There is no affect on the printing quality though noise may occur during paper feeding depending on the paper type.

The operating procedure for bypass copying differs depending on the paper size to be used. See the table below for the operating procedure of each size.

Paper size		Procedure
Standard size	Other than North America: A3, A4, B4, B5 North America: LD, LT, LG, ST-R	📖 P.33 “Copying on A3, A4, B4 and B5 size paper (in equipment other than for North America) / LD, LT, LG and ST-R size paper (in equipment for North America)”
	Other than the above	📖 P.35 “Copying on other than the above standard sizes of paper”
	Envelope	📖 P.37 “Copying on an envelope”
Others (Non-standard sizes)		📖 P.38 “Bypass copying on non-standard size paper”

■ Bypass copying on standard size paper

Note

If the paper size is not selected in this step, copying may be slowed down.

□ Copying on A3, A4, B4 and B5 size paper (in equipment other than for North America) / LD, LT, LG and ST-R size paper (in equipment for North America)

1 Place paper on the bypass tray.

To learn how to place paper on the bypass tray, refer to the *Paper Preparation Guide*. When paper is placed, the menu for bypass copying appears.

2 Select the same size button under “Copy” as that of the paper you placed on the bypass tray.

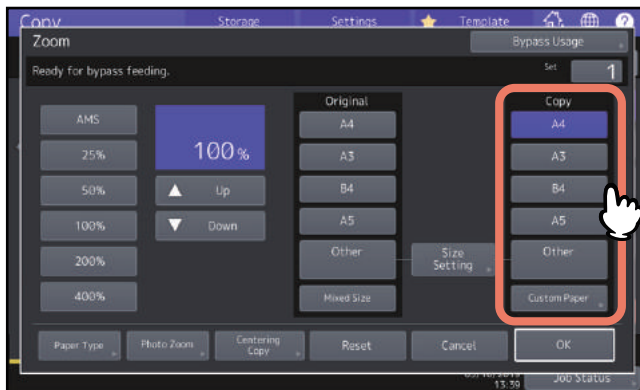

The paper size is now set.

3 Press [Paper Type] on the touch panel if the paper type of the paper you placed on the bypass tray is other than plain paper.

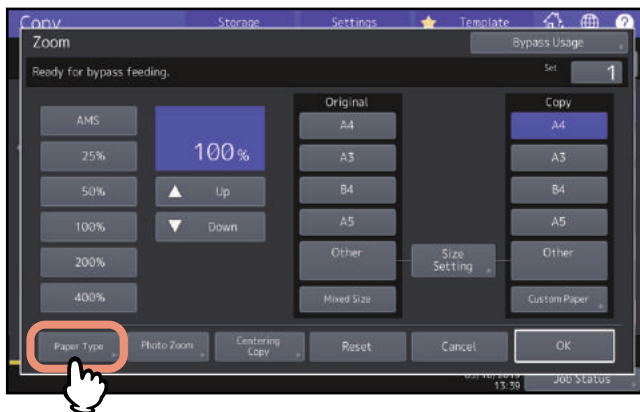

4 Select the tray and paper type, and press [OK].



Note

- Automatic 2-sided printing cannot be applied to some kind of paper on the bypass tray. For the paper which Automatic 2-sided printing cannot be applied to, refer to the **Specifications Guide**.
- For OHP films (TRANSPARENCY), only 1-sided copying can be performed.
- If paper cannot be fed, printing takes a long time after feeding or the quality is poor, turn over the paper and place it again or place fewer sheets.

Tip

To automatically make 2-sided copies, press [None] under “Back Printed” and make 2-sided copy settings.

 P.64 “Making a 2-sided copy”

To print on the back side of the paper, press [Printed] under “Back Printed”.

Manual copying on the back side of the paper

When copying the back side of the paper which automatic 2-sided printing cannot be applied to or when making 2-sided copies manually, select a paper type for one side and make a copy of it, and then select the same paper type and press [Printed] under “Back Printed” for the other side.

Example: When making a 2-sided copy on Thick 2 paper

1. Place paper on the bypass tray.
2. Select “Thick 2” for the paper type and start copying.
3. Place the paper copied in step 2 on the bypass tray again with its copied side up.
4. Select “Thick 2” for the paper type and [Printed] under “Back Printed”, and then start copying.

5 After setting the paper size and type, press [OK].

The menu returns to the Basic menu.

6 Select other copy modes as required, and then press the [START] button on the control panel.

❑ Copying on other than the above standard sizes of paper

1 Place the original(s) and paper on the bypass tray.
To learn how to place paper on the bypass tray, refer to the *Paper Preparation Guide*.
Placing paper displays the paper setting menu for bypass copying.

2 Press [Size Setting] on the touch panel.

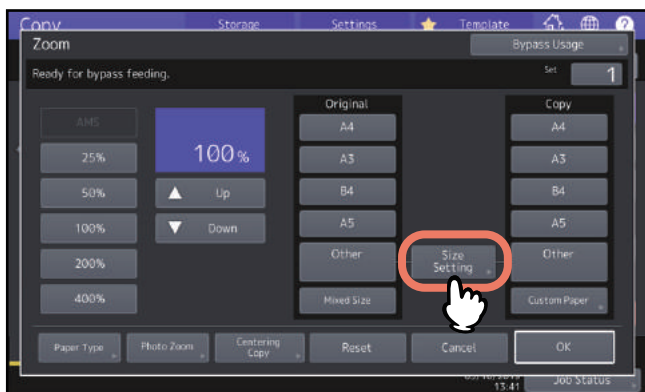

3 Press the button of the same size as the paper you placed on the bypass tray.

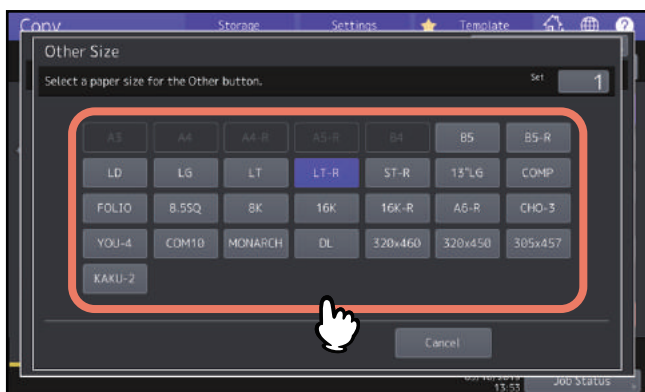

The selected size will be registered as an “Other” size.

4 Press [Other] under “Copy”.

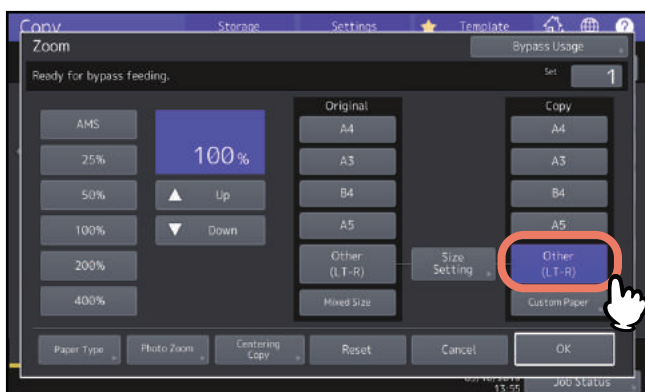

The paper size is now set to the one registered as “Other” size.

5 Press [Paper Type] if the paper you placed on the bypass tray is other than plain paper.

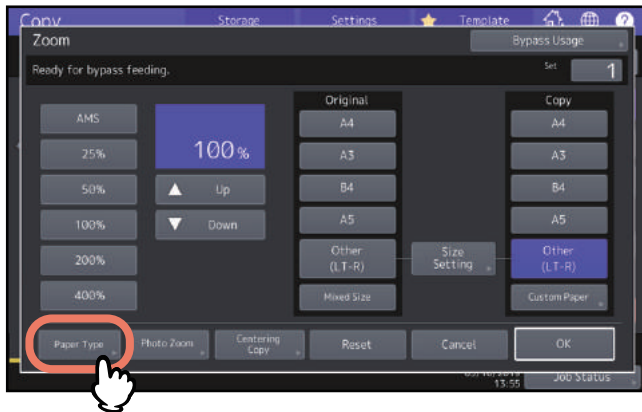

6 Select the paper type and press [OK].



Tip

To print on the back side of the paper, press [Printed] under “Back Printed”.
To automatically make 2-sided copies, press [None] under “Back Printed” and make 2-sided copy settings.
 P.64 “Making a 2-sided copy”

7 After setting the paper size and paper type, press [OK].

The menu returns to the Basic menu.

8 Select other copy modes as required, and then press the [START] button on the control panel.

❑ Copying on an envelope

Note

- Store envelopes at room temperature and away from heat and moisture.
- Paper wrinkling may occur after printing depending on environment or the envelope type or condition. We recommend printing paper as a sample before doing so in large amounts.
- Every 10 copies, take the envelopes out from the exit tray.

1 Place the original on the original glass.

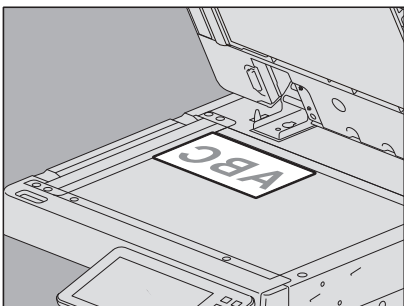

2 Place paper on the bypass tray.

To learn how to place paper on the bypass tray, refer to the *Paper Preparation Guide*. When paper is placed, the menu for bypass copying appears.

3 Press [Size Setting] on the touch panel.

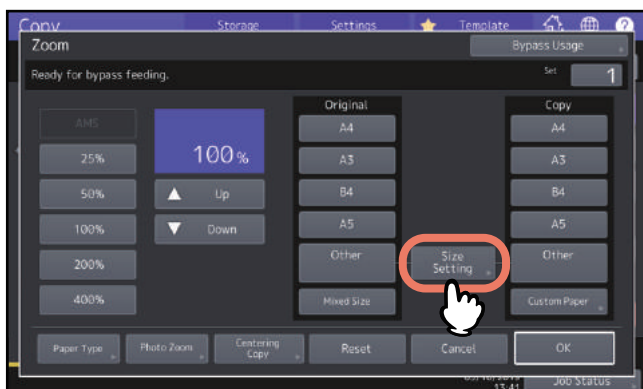

4 Press the button of the same size as the envelope you placed on the bypass tray.

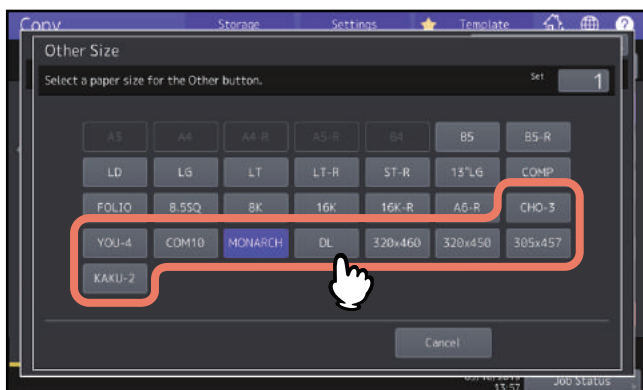

The size of the selected envelope will be registered as an “Other” size.

5 Press [Other] under “Copy” and press [OK].

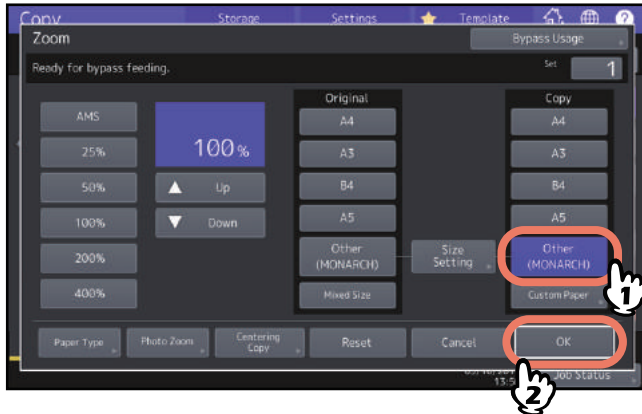

The paper size is now set to the size of the envelope placed on the bypass tray. The paper type is automatically set to [Envelope].

6 Select other copy modes as required, and then press the [START] button on the control panel. Copying starts.

■ Bypass copying on non-standard size paper

You can specify the size of non-standard size paper and copy it. For paper size which can be set, refer to the *Specifications Guide*.

1 Place the original.

2 Place paper on the bypass tray.

To learn how to place paper on the bypass tray, refer to the *Paper Preparation Guide*. When paper is placed, the menu for bypass copying appears.

3 Press [Custom Paper] on the touch panel.

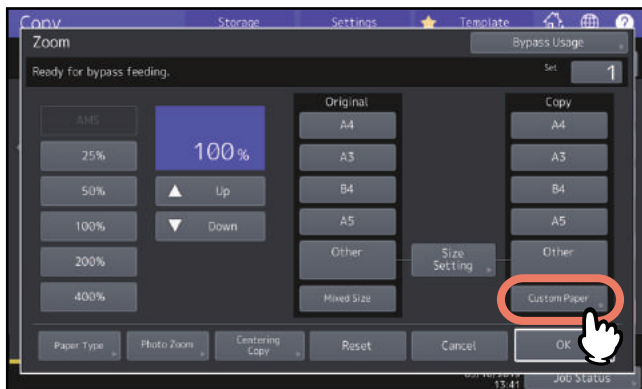

4 Key in the dimension, and press [OK].

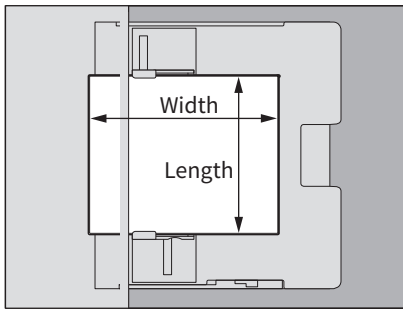
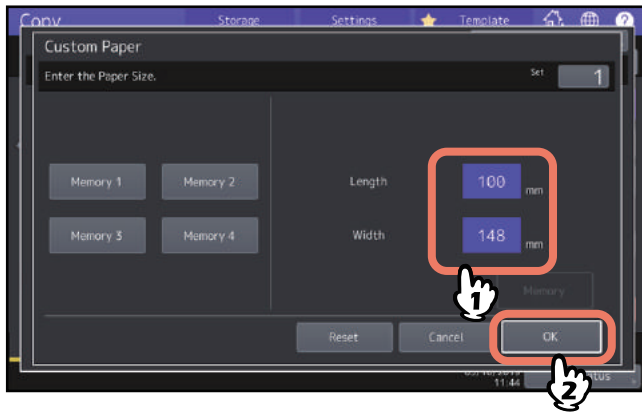

Tip

To call up the dimension data registered previously, press the desired button from [Memory 1] to [Memory 4], and then press [OK].

To register dimension data into the memory, see the following page:

P.47 “Registering non-standard size in the memory”

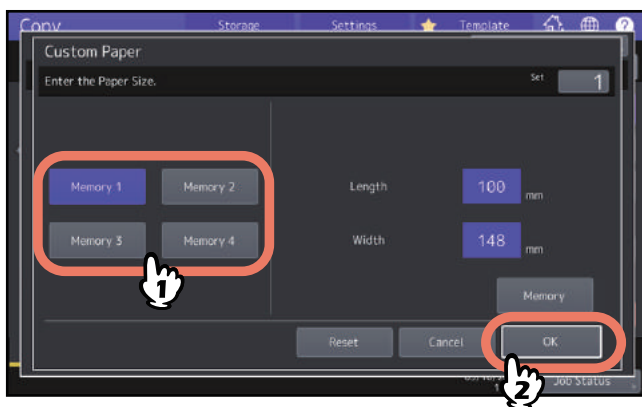

5 Select other copy modes as required, and then press the [START] button on the control panel.

Selecting Exit Tray

You can select the exit tray if the finisher or the Job Separator is installed.

Note

- The available exit tray may be restricted depending on copy modes and paper sizes.
- Exit tray selection is set at automatic selection by default.

■ Changing the exit tray

The exit tray currently selected is displayed on the equipment status indication area. To change the exit tray, press [Exit Tray]. Every time you press this, the display changes from the exit tray of the equipment, each exit tray of the finisher and Job Separator, and automatic selection in this order.

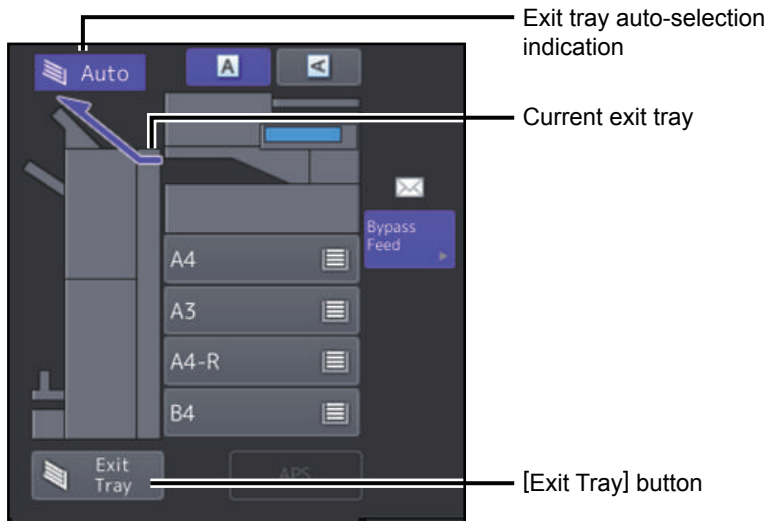

Switching Color Modes (Color Model only)

You can switch the color mode. There are 3 color modes as shown below.

Full Color: All originals are copied in full colors. (Default)

Black: All originals are copied in black and white.

Auto Color: The equipment automatically judges the type of each color on originals. Colored originals are copied in full colors and black-and-white originals are copied in black and white.

Press any of [Full Color], [Black] or [Auto Color] on the touch panel.

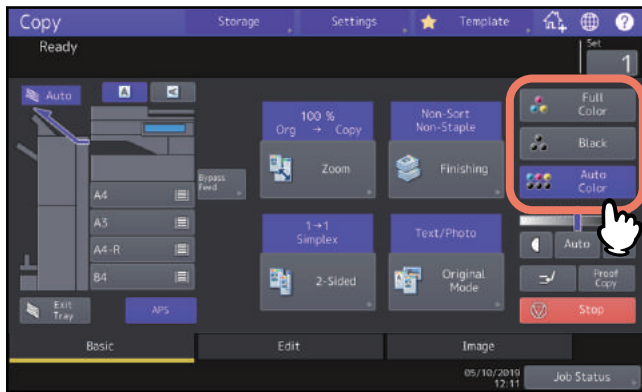

Note

When you select [Auto Color], some originals may not be copied exactly as they look, such as the cases shown below. Select either [Full Color] or [Black].

- **When color originals are copied in black**

Example:

- Originals whose colored area is extremely small
- Originals which are completely black
- Originals whose colors are light

- **When black originals are copied in full colors**

Example:

- Yellowish originals
- Originals with a colored background

Tip

The sensitivity to detect whether the data scanned in auto color are color or black can be changed. For details, refer to the ***MFP Management Guide***.

Adjusting Density

This equipment detects the density level of originals and automatically adjusts the density level of the copied image to the optimal one. Alternatively, you can manually adjust it to the desired level.

■ Adjusting automatically (automatic density adjustment)

Press [Auto] on the touch panel.

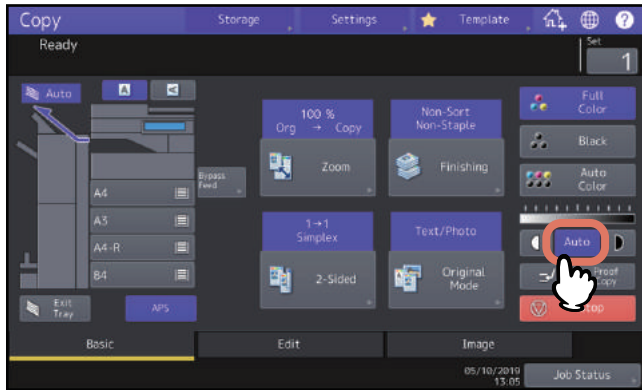



Tip

The default setting of the automatic density adjustment is as follows according to the color modes:

Full Color or Auto Color: OFF

Black: ON

■ Adjusting manually

Press either  or  to select the desired density level.

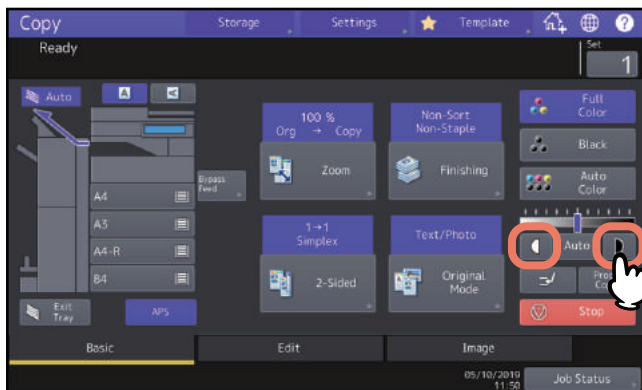

Enlarging or Reducing Images

You can change the reproduction ratio of copied images in the following procedures:

Automatic Magnification Selection (AMS):

You need to specify the copy paper size in advance. Then this equipment will detect the original size and automatically select the optimal reproduction ratio for the copy paper size.

Specifying both original size and copy paper size separately:

You need to specify both the original size and the copy paper size separately in advance. According to the sizes you specified, the optimal reproduction ratio is selected automatically. This feature is used when Automatic Magnification Selection is not available, such as when copying OHP film originals.

Specifying reproduction ratio manually:

You can select the desired reproduction ratio by pressing [Zoom] or one-touch zoom buttons on the touch panel.

Copying photo originals in the optimal reproduction ratio for copy paper size (Photo Zoom):

You can copy photo originals in the reproduction ratio best suited to the copy paper size.

Reducing images to scan the entire original, including the edges (Full Image):

You can copy an entire original including images and notes on the edge. Copied originals are reduced by 1 to 5% so that the entire part fits into the paper size.

Tip

The available range of reproduction ratio differs depending on whether the original is placed on the original glass or the ADF.

- Original glass: 25 to 400%
- ADF: 25 to 200%

■ Automatic Magnification Selection (AMS)

Specify the copy paper size in advance so that this equipment will detect the original size and automatically select the optimal reproduction ratio to the copy paper size.

This function is available when the size of the originals is as follows:

North America: LD, LG, LT, LT-R, ST-R and COMP (COMP is available only when the ADF is used.)

Other than North America: A3, A4, A4-R, A5-R, B4, B5, B5-R, FOLIO (FOLIO is available only when the ADF is used.)

Note

This function does not work properly for the originals noted below. Select other methods when copying them.

- Highly transparent originals (e.g. OHP film, tracing paper)
- Totally dark originals or ones with dark borders
- Non-standard size originals (e.g. newspapers, magazines)

1 Press [Zoom] on the Basic menu.

2 Select the desired paper size, press [AMS] and then [OK].

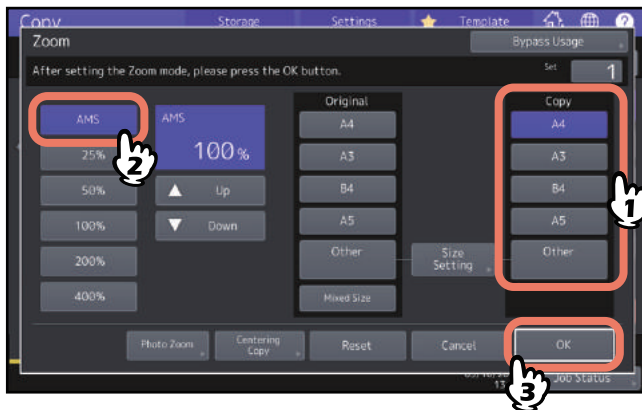

Tip

- If you want to select a paper size other than the following, you need to register the size as “Other”. Once you register this size, it will be specified every time you press [Other] on the touch panel.
North America: LD, LG, LT, ST
Other than North America: A3, A4, B4, B5
For how to register, see the following page:
[P.46 “Registering paper sizes to “Other” size”](#)
- Paper sizes can also be registered by pressing the desired drawer button of the equipment status indication area on the Basic menu.

3 Place the original(s).

If the original is placed on the original glass, the reproduction ratio is set when the original is placed. If the original is placed on the ADF, the reproduction ratio is set when the original is scanned.

Note

If “Change direction of original” appears, change it accordingly.

■ Specifying both the original size and the copy paper size separately

- 1 Press [Zoom] on the Basic menu.
- 2 Select the desired sizes for the original and copy paper, and then press [OK].



Tip

- If you want to select a size other than the following for the original size and copy paper size, you need to register the size as “Other”. Once you register this size, it will be specified every time you press [Other] on the touch panel.
 North America: LD, LG, LT, ST
 Other than North America: A3, A4, B4, B5
 For how to register, see the following page:
[P.46 “Registering paper sizes to “Other” size”](#)
- Paper sizes can also be registered by pressing the desired drawer button of the equipment status indication area on the Basic menu.

❑ Registering paper sizes to “Other” size

If you want to select a size other than the following for the original size and copy paper size, you need to register the size as “Other” following the procedures below. Once you register this size, it will be specified every time you press [Other] on the touch panel.

North America: LD, LG, LT, ST

Other than North America: A3, A4, B4, B5

Note

You can register only standard sizes as [Other] and cannot register any non-standard sizes.

1 Press [Size Setting] on the touch panel.

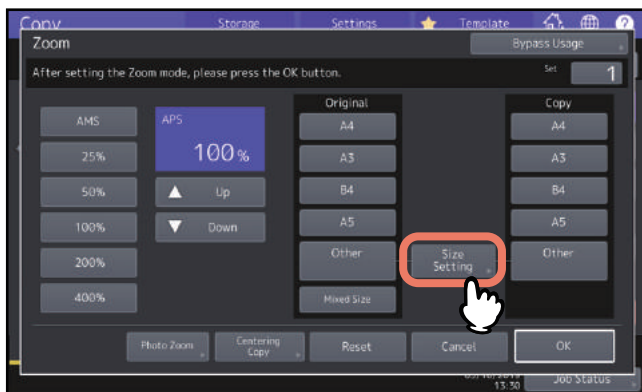

2 Select the desired size.

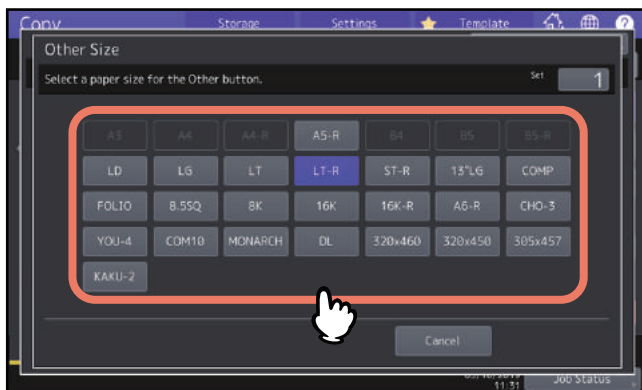

The selected size will be registered as an “Other” size.

❑ Registering non-standard size in the memory

1 Follow the same procedure noted in steps 1 to 3 in “Bypass copying on non-standard size paper” (P.38).

2 Register dimensions.

Select a desired memory number and enter the values in [Length] and [Width]. After entering required information, press [Memory].

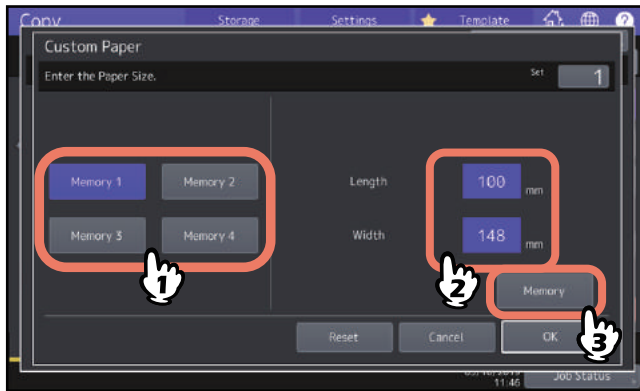

■ Specifying reproduction ratio manually

- 1 Press [Zoom] on the Basic menu.
- 2 Press the buttons below to select the desired reproduction ratio.
[▲ Up] and [▼ Down] buttons

The reproduction ratio changes by 1% every time either of them is pressed. When you hold either down, the ratio goes up or down automatically.

One-touch zoom buttons

Select the desired ratio from [400%], [200%], [100%], [50%] and [25%].

Note

When the ADF is used, the maximum ratio available is 200%.

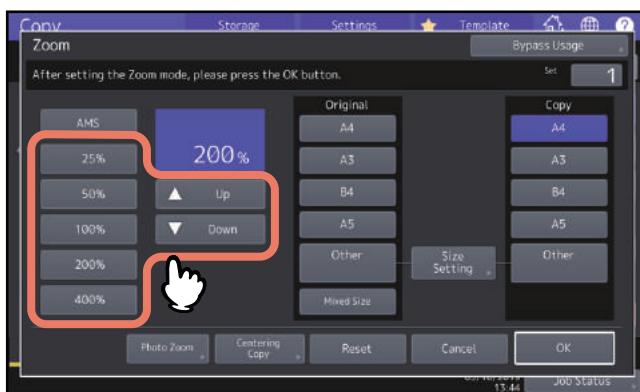

- 3 Select the desired size, and then press [OK].

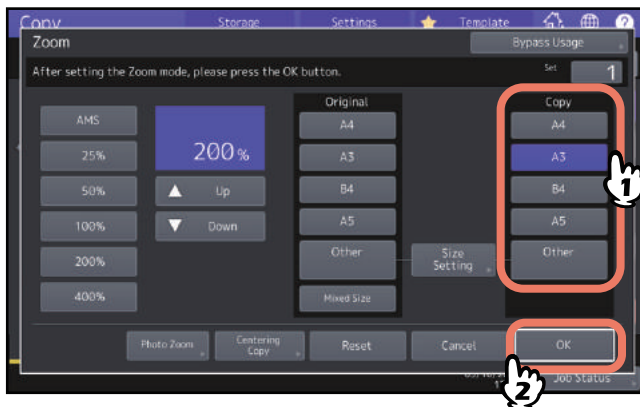

Tip

- If you want to select a paper size other than the following, you need to register the size as "Other". Once you register this size, it will be specified every time you press [Other] on the touch panel.
North America: LD, LG, LT, ST
Other than North America: A3, A4, B4, B5
For how to register, see the following page:
📖 P.46 "Registering paper sizes to "Other" size"
- Paper sizes can also be registered by pressing the desired drawer button of the equipment status indication area on the Basic menu.

■ Copying photo originals in the optimal reproduction ratio for copy paper size (Photo Zoom) (Color Model only)

Note

- Place the original on the original glass in a landscape direction.
- If you want to select a paper size other than the following, you need to register the size as “Other” size. In this case, register it in a landscape direction. Once you register this size, it will be specified every time you press [Other] on the touch panel.

North America: LD, LG, LT, ST

Other than North America: A3, A4, B4, A5

For how to register it, see the following page:

📖 P.46 “Registering paper sizes to “Other” size”

1 Press [Zoom] on the Basic menu.

2 Press [Photo Zoom].

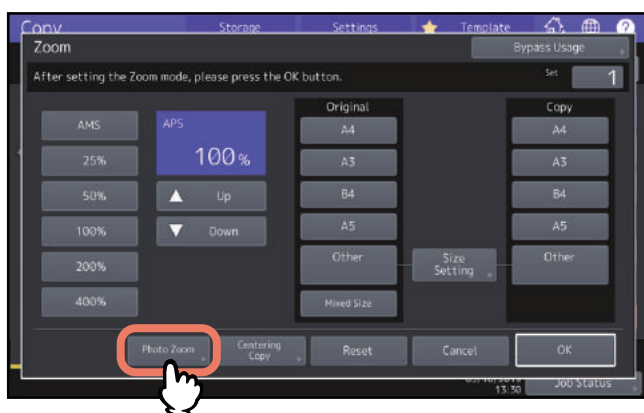

3 Select the original size.

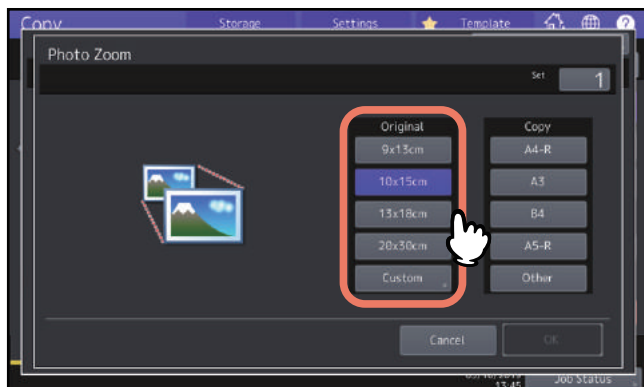

Note

The actual size for the [3" x 5"] button is 3.5" x 5.0".

Tip

When the size of the original is other than the ones below, key in the dimension of the original manually.

North America: 3" x 5", 4" x 6", 5" x 7" or 8" x 10"

Other than North America: 9 x 13 cm, 10 x 15 cm, 13 x 18 cm or 20 x 30 cm

📖 P.51 “Setting photo originals in other sizes”

4 Select the desired copy paper size, and then press [OK].

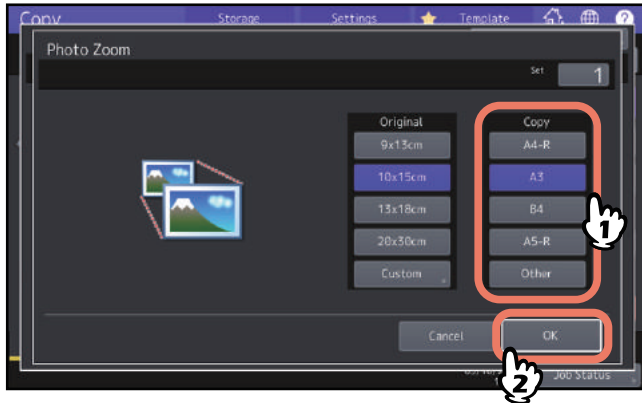

5 Select other copy modes as required, and then press the [START] button on the control panel.
If “Non-Sort Non-Staple” is selected as a sorting mode, scanning of the original starts. If another sorting mode is selected, follow the procedure below.

6 Place the next original, and then press [Next Copy] on the touch panel or the [START] button on the control panel.
Scanning of the next original starts. If you have more than one original, repeat this step until the scanning of all the originals is finished.

7 When the scanning of all the originals is finished, press [Job Finish] on the touch panel.
Copying starts.

❑ Setting photo originals in other sizes

1 Press [Custom] on the touch panel.

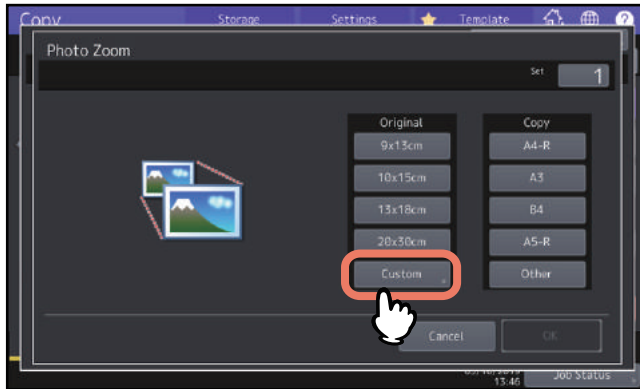

2 Key in the size of the original, and press [OK].

[Length]: 10 mm to 434 mm (0.39" to 17.09")

[Width]: 10 mm to 300 mm (0.39" to 11.81")

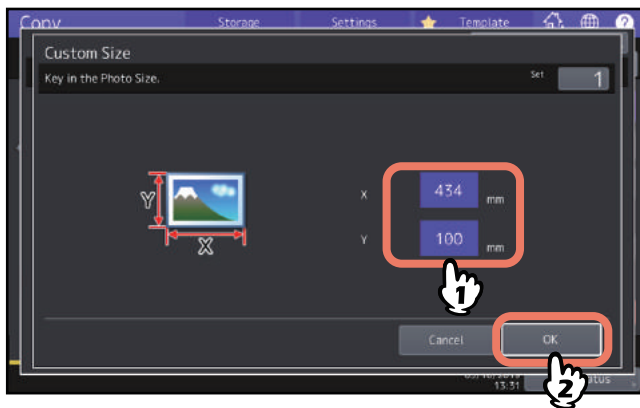

Tip

Regardless of an original direction, enter the original width in [X] and the original length in [Y] viewed from the front of the equipment.

■ Reducing images to scan the entire original, including the edges (Full Image) (Color Model only)

You can copy the entire image of an original including any fine text at its edge. This function is called “full image”. With this function, the image will be copied with its reproduction ratio reduced by approx. 1 to 5%.

- 1 Press [Zoom] on the Basic menu.
- 2 Select sizes for the original and copy paper, and press [OK].

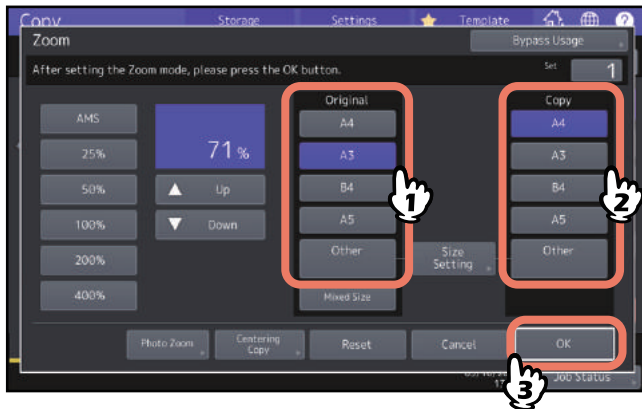

The menu returns to the Basic menu.

- 3 Press [Full Image] on the Edit menu.

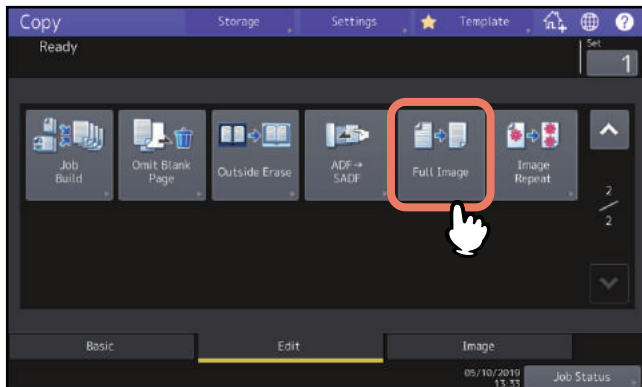

■ Reducing and Centering an Image (Centering Copy)

You can make a copy with a scanned image reduced and moved to the center of the paper.

1 Press [Zoom] on the Basic menu.

2 Select a desired reproduction ratio.

P.48 “Specifying reproduction ratio manually”

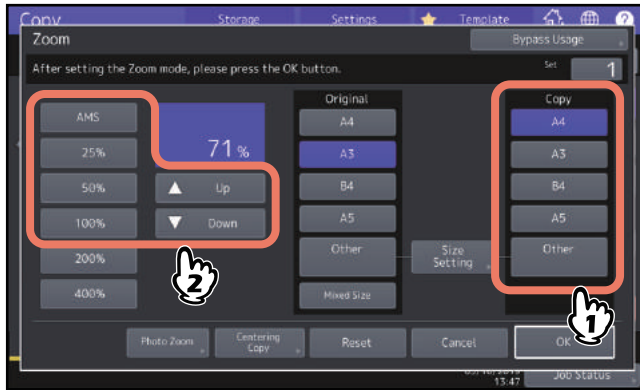

3 Press [Centering Copy].

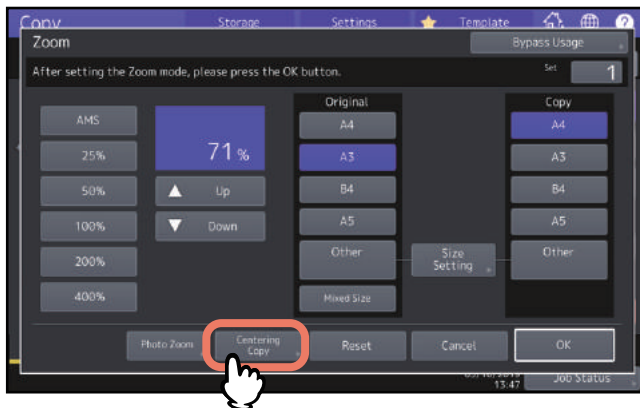

4 Press [OK] on the displayed centering copy screen.

5 Press [OK] on the [Zoom] screen.

Selecting Finishing Mode

■ Finishing modes and optional finishing devices

See the table below for each finishing mode.

Finishing mode	Description
Non-sort Non-staple	Copies exit without being sorted or stapled.
Sort (📖 P.55)	Copies exit in the offset mode (shift exiting) in the same page order as the originals one set after another.
Group (📖 P.55)	Copies grouped by page exit in the offset mode (shift exiting).
Rotate sort (📖 P.56)	Copies exit in the offset mode (shift exiting) set by set alternately in a different direction.
Staple sort (📖 P.57)	Copies exit with their corner stapled.
Magazine sort (📖 P.58)	Copies exit in a book-type page order.
Center fold (📖 P.58)	Copies exit in a book-type page order with their center folded.
Saddle stitch (📖 P.58)	Copies exit in a book-type page order with their center folded and stapled.
Magazine sort & center fold (📖 P.58)	Magazine sort and center fold are used together.
Magazine sort & saddle stitch (📖 P.58)	Magazine sort and saddle stitch are used together.
Hole punch (📖 P.61)	Copies exit with their side punched.
Manual staple (Paper Preparation Guide)	Copies are stapled manually.

The available finishing modes differ depending on the type of optional finishing devices (Finisher and Hole Punch Unit) installed. For which optional finishing devices can be used with this equipment, refer to the **Specifications Guide**.

Sort and group mode

When you make more than one set of copies, they can be made to exit in the same page order as that of the originals. This mode is called the sort mode. Copies can also be made to exit grouped by page. This mode is called the group mode. When the sort and group mode is selected, copies automatically exit in the offset mode (shift exiting) by shifting the exit position for each sorted set.

Sort mode

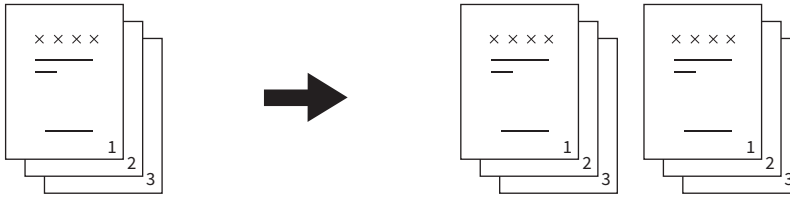

Group mode

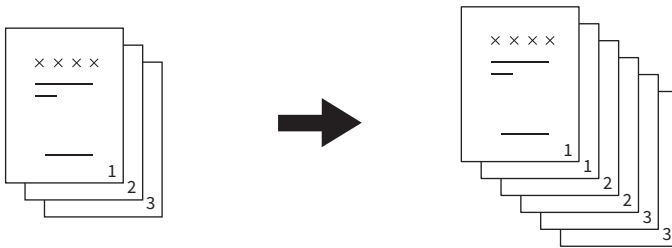

Note

Even when the sort and group mode is selected, the offset mode (shift exiting) does not work depending on exit trays and paper size. For each corresponding condition, refer to the **Specifications Guide**.

Tip

When you place originals on the ADF, the display of the sorting mode button will change to “Sort”.

- 1 Press [Finishing] on the Basic menu.
- 2 Select [Sort] or [Group], and then press [OK].

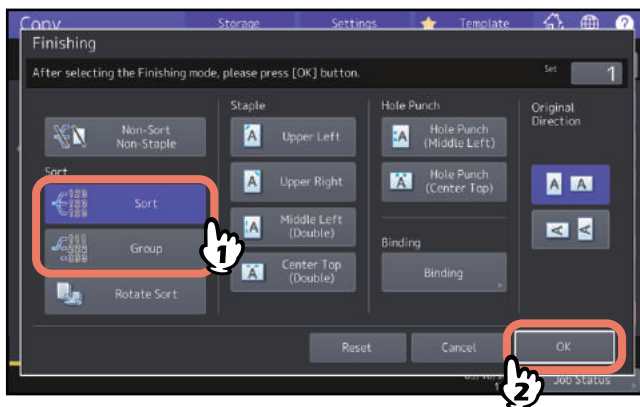

- 3 Key in the desired number of copies on the Basic menu.

■ Rotate sort mode

When you make more than one set of copies, one set can be made to exit on top of another set, alternating in portrait and landscape directions. This mode is called the rotate sort mode. Use 2 drawers and 2 stacks of paper of the same size. Place one stack of paper in one drawer in a portrait direction and place the other in another drawer in a landscape direction before you start copying. When the rotate sort mode is selected, copies automatically exit in the offset mode (shift exiting).

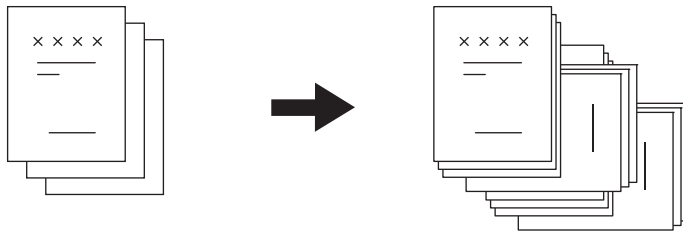

Note

- A4, B5 and LT sized paper placed on the drawer or bypass tray can be used.
- The rotate sort mode is not available when Automatic Paper Selection is selected.
- Place one stack of paper in one drawer in a portrait direction and place the other in another drawer in a landscape direction.
- Pull out the sub-tray of the finisher when an attempt to copy is made with the rotate sort mode. The output paper will be more likely to be aligned properly.
- Even when the rotate sort mode is selected, the rotate sort mode does not work depending on exit trays and paper size. In this case, copies exit in the sort mode without shift exiting. For each corresponding condition, refer to the Specifications Guide.
- Stains may appear on the edge of the paper. In such a case, this will be reduced by changing the setting of the printing interval to be longer. For the details of the setting, ask your service technician. Refer to the **Software Troubleshooting Guide** about the problem of stains on the edge of the paper.

1 Press [Finishing] on the Basic menu.

2 Select [Rotate Sort], and then press [OK].

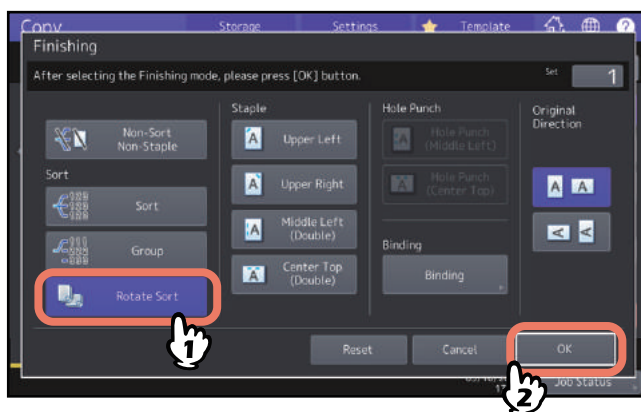

3 Key in the desired number of copies on the Basic menu.

■ Staple sort mode

When you make more than one set of copies, the copied paper can be automatically stapled set by set. This mode is called the staple sort mode. You can choose from 4 different stapling positions.

Example: When [Upper Left] for the staple is selected

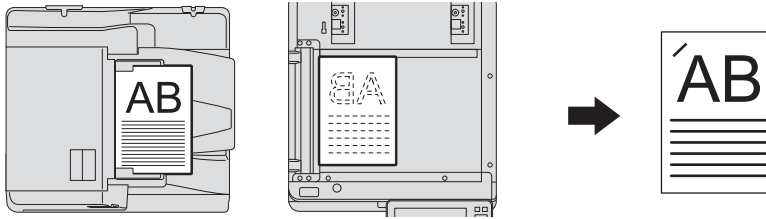

Note

- Special paper such as OHP film or sticker labels is not applicable.
- Copies in different sizes cannot be stapled unless their length is the same.
- An error occurs if the stapling position is not appropriate for the selected paper size.

Tip

When the number of sheets exceeds the maximum number of sheets available for stapling, this equipment automatically enters into the sort mode.

1 Press [Finishing] on the Basic menu.

2 Press the button for the staple position, select the direction that matches the original you set from “Original Direction”, and press [OK].

Set the staple position based on the button icons and original direction icons.

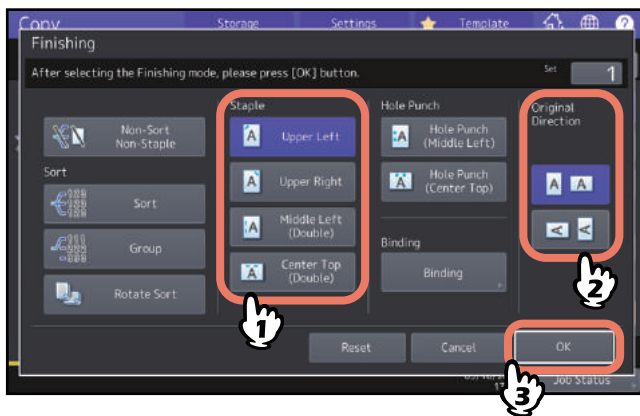

Tip

“Original Direction” can be set on the Copy menu.

📖 P.13 “Equipment status indication area”

■ Magazine sort / Center fold / Saddle stitch

You can copy more than one original and bind them in a booklet format (Magazine sort).

With the Saddle Stitch Finisher, you can also have the copied booklet folded at its center (Center fold) and besides stapled (Saddle stitch).

Note

- Saddle stitch and center folding can be selected only when the Saddle Stitch Finisher option is installed. To learn more about the specifications of options, refer to the **Specifications Guide**.
- Special paper such as OHP film or sticker labels is not applicable.
- A3, A4-R or B4 size paper can be used. A5-R and B5-R size paper can also be used for the magazine sort mode.

Magazine sort mode

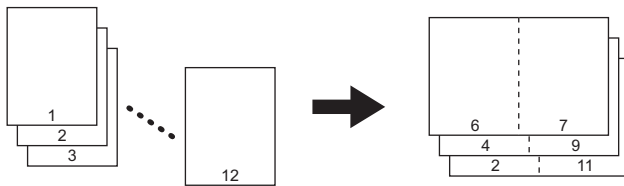

Center fold mode

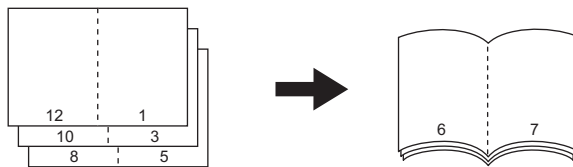

Saddle stitch mode

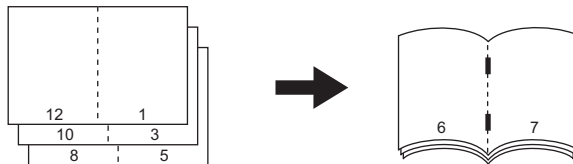

Magazine sort & center fold mode

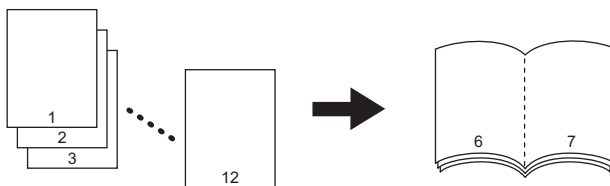

Magazine sort & saddle stitch mode

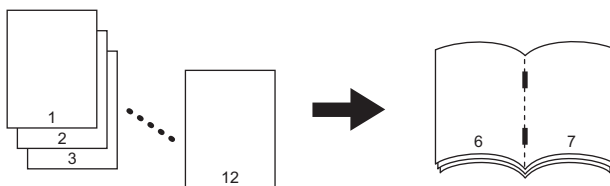

Tip

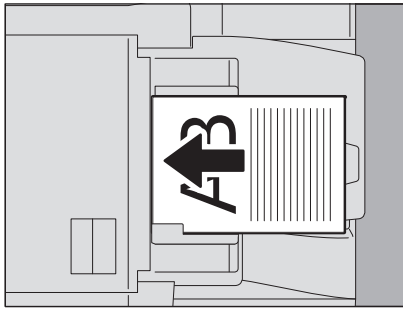

When placing portrait originals in a landscape direction as shown above in the magazine sort mode, the magazine sort & center fold mode, or the magazine sort & saddle stitch mode, confirm that the appropriate orientation setting is specified. When the placed original faces to the front (with its bottom toward you), press **[A]**. When the original faces to the side (with its bottom to the right), press **[<]**.
 ⓘ P.26 “Specifying the orientation of originals”

1 Place the original(s).

When placing the originals on the ADF, place them according to the illustration on the previous page. When placing the originals on the original glass, place them in the following order:

- **Magazine sort, Magazine sort & center fold, Magazine sort & saddle stitch:** Place the first page of the original first.
- **Center fold, Saddle stitch:** For example, if the total number of pages is 12, place pages 1 and 12 together, and then pages 2 and 11, 10 and 3, 4 and 9, 8 and 5, and finally pages 6 and 7.

2 Press [Finishing] on the Basic menu.

3 Select the direction that matches the direction you set from “Original Direction”, and press [Binding].

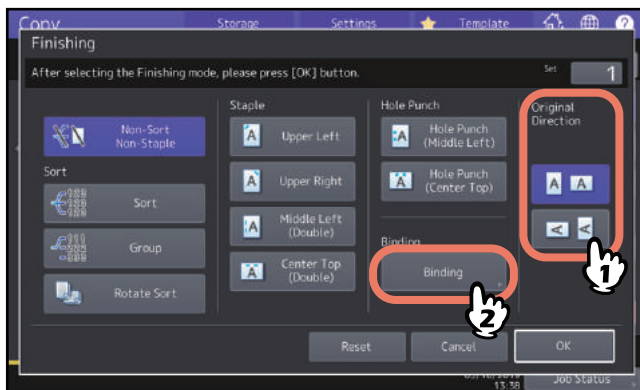

Tip

“Original Direction” can be set on the Copy menu.
 ⓘ P.13 “Equipment status indication area”

4 Select a binding mode and press [OK].

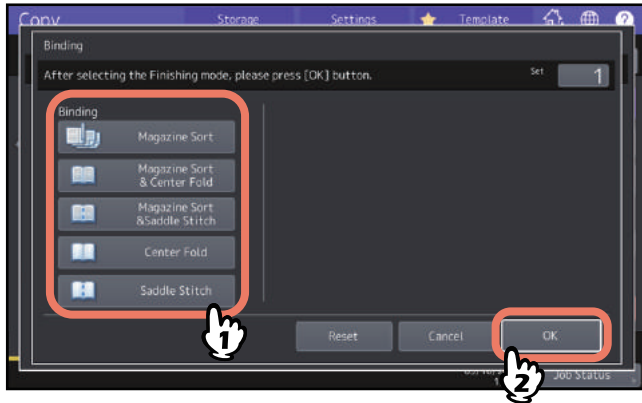

5 When you select [Magazine Sort], [Magazine Sort & Center Fold], or [Magazine Sort & Saddle Stitch], specify the binding margin and press [OK].

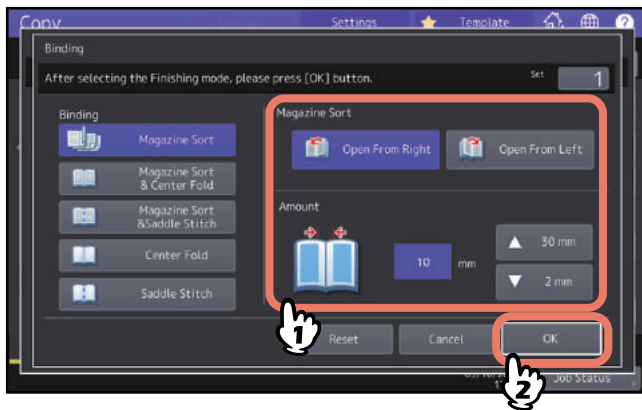

6 Combine the copied paper if the center fold mode or magazine sort & center fold mode is used.

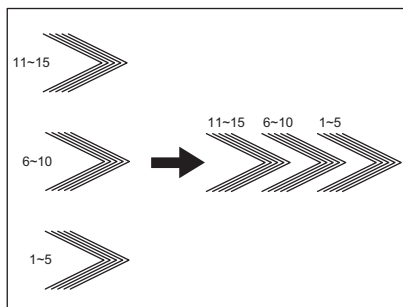

In the center fold mode, paper is folded at the center for every 5 sheets before exiting. If more than 5 sheets of paper are copied, combine them as shown in the figure.

■ Hole punch mode

You can punch copied paper when the Hole Punch Unit is installed on the Finisher. You can choose from two positions of holes.

Note

- To learn about supported paper types, refer to the *Specifications Guide*.
- Special paper such as OHP film or sticker labels is not applicable.

1 Press [Finishing] on the Basic menu.

2 Select [Hole Punch] and [Original Direction], and then press [OK].

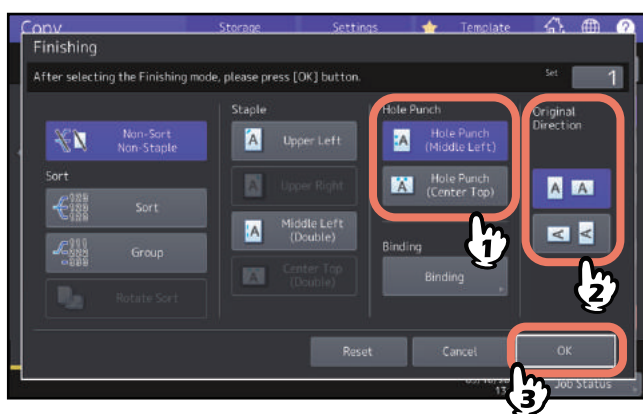

Duplex Copying

You can copy a 1-sided original to a 2-sided copy or vice versa, or copy a 2-sided original to a 2-sided copy. This is useful when you want to save the paper, or when you want to copy a book-type original maintaining the same page order. As for the directions of originals or copied images, “open to left” is called “book” and “open to top” is called “tablet”.

1-sided original -> 1-sided copy (📖 P.63)

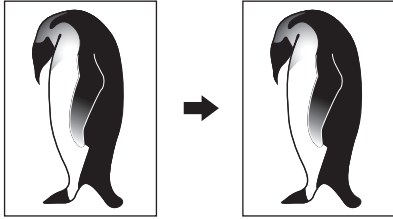

2-sided original -> 1-sided copy (📖 P.63)

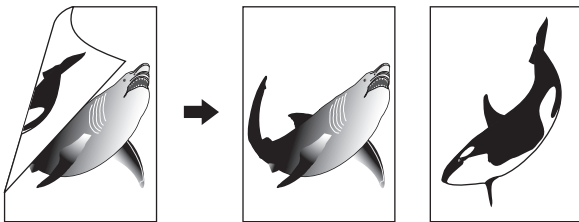

1-sided original -> 2-sided copy (📖 P.64)

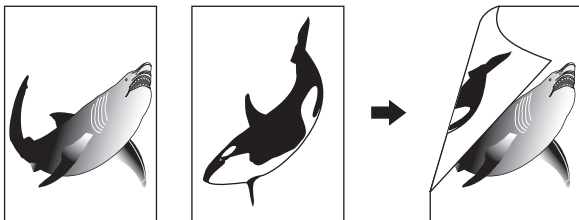

2-sided original -> 2-sided copy (📖 P.64)

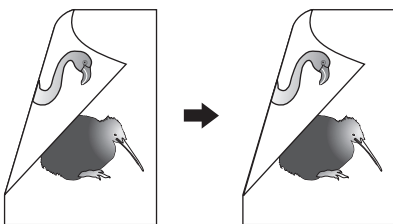

Book-type original -> 2-sided copy (📖 P.65)

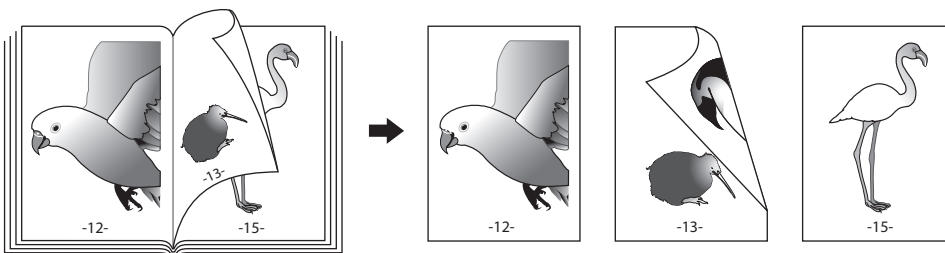

Note

Supported paper types for duplex copying differ depending on your model. To learn which types of paper are supported, refer to the **Specifications Guide**.

■ Making a 1-sided copy

Tip

Specify the appropriate orientation and binding direction settings for the placed original. If the setting does not match the actual orientation of the original, it will be printed in an unintended direction.

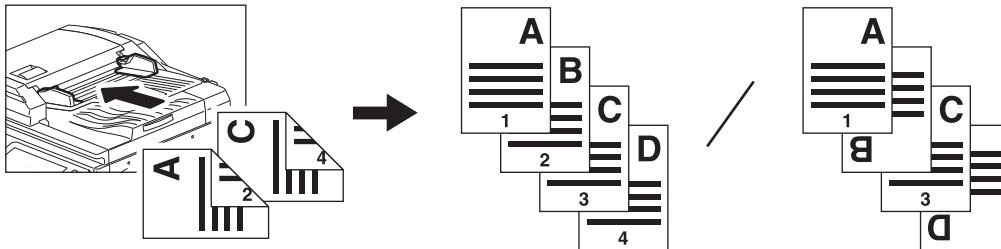

- 1 Press [2-Sided] on the Basic menu.
- 2 Select the desired mode and original direction, and then press [OK].
 [1->1 Simplex]: 1-sided original to 1-sided copy
 [2->1 Split]: 2-sided original to 1-sided copy

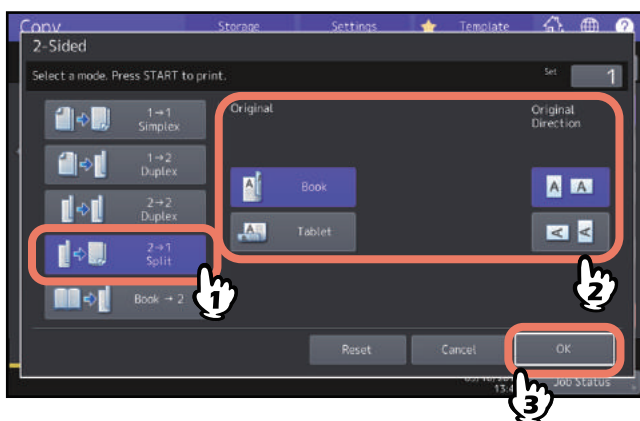
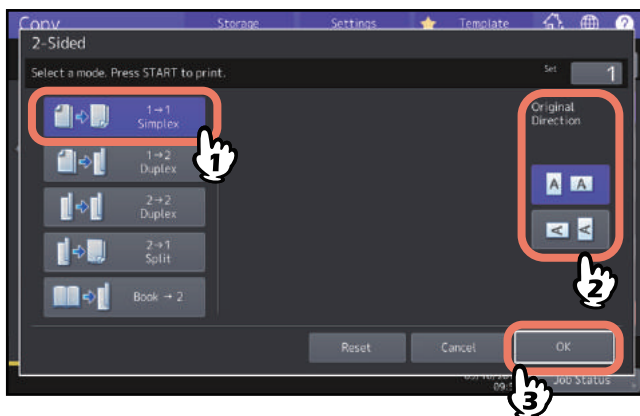

Tip

“Original Direction” can be set on the Copy menu.

📖 P.13 “Equipment status indication area”

■ Making a 2-sided copy

Tip

Specify the appropriate orientation and binding direction settings for the placed original. If the setting does not match the actual orientation of the original, it will be printed in an unintended direction.

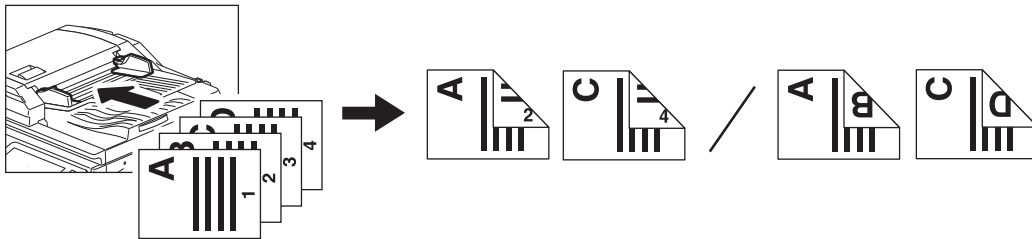

1 Press [2-Sided] on the Basic menu.

2 Select the desired mode, book or tablet of original and paper, and original direction, and then press [OK].

[1 -> 2 Duplex]: 1-sided original to 2-sided copy

[2 -> 2 Duplex]: 2-sided original to 2-sided copy

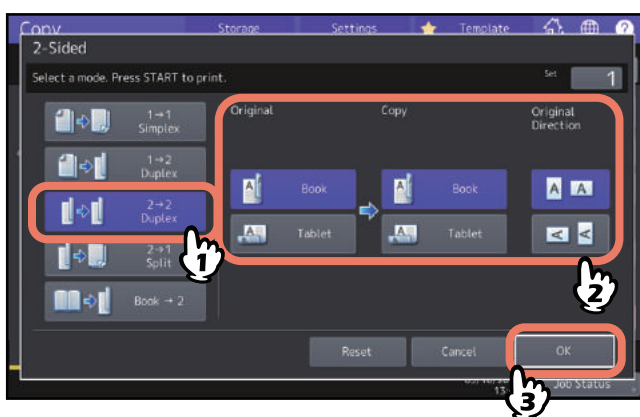
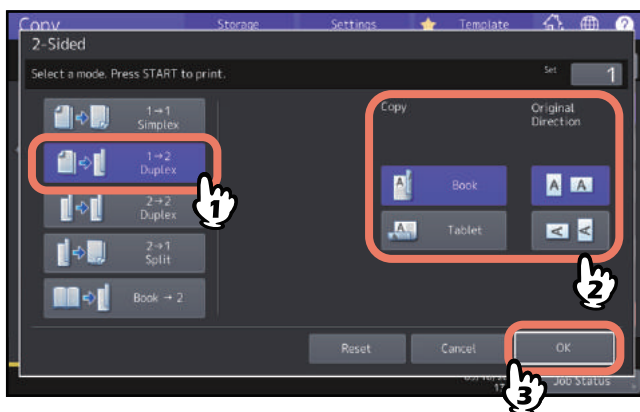

Tip

“Original Direction” can be set on the Copy menu.

📖 P.13 “Equipment status indication area”

■ Making a 2-sided copy from a book-type original

You can make 2-sided copies from book-type originals such as books or catalog as in the same page order.

Tip

A4, B5 and LT sizes are applicable.

1 Press [2-Sided] on the Basic menu.

2 Select [Book -> 2].

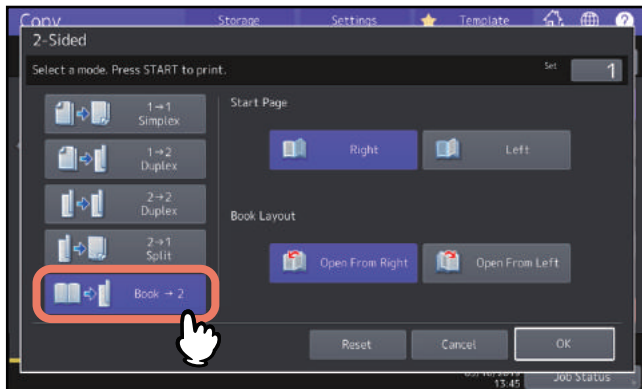

3 Select the start page to be scanned and page layout.

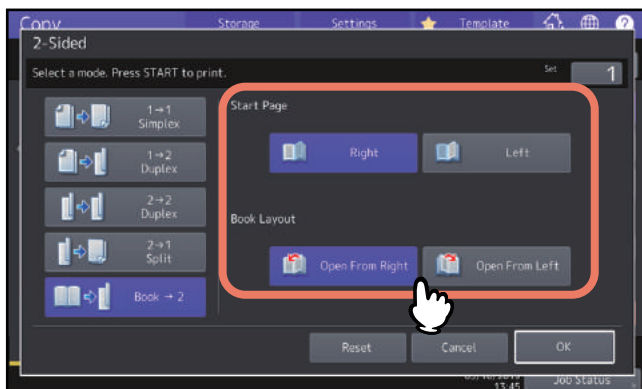

Note

Open from Right: For books which you turn pages from the right side (mainly for books with horizontal writing).
Open from Left: For books which you turn pages from the left side (mainly for books with vertical writing).

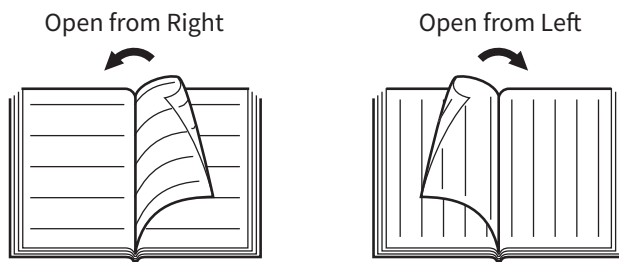

Example: If pages 2 to 6 of a book which opens to the left are to be copied, select [Left] and [Open from Right].

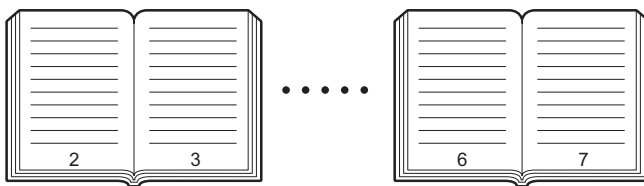

4 Press [OK].

The menu returns to the Basic menu.

5 Press the drawer button corresponding to the desired paper size.

Only A4, B5 and LT sizes are applicable.

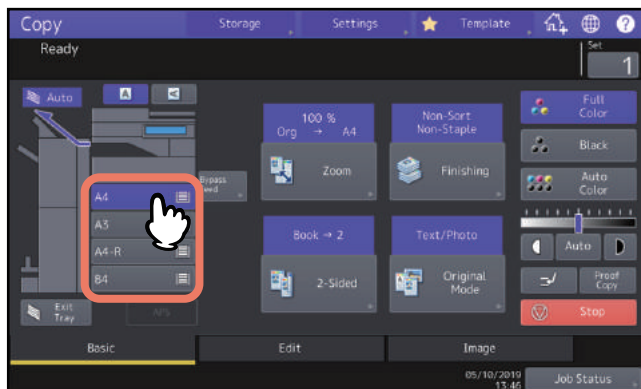

6 Select other copy modes as required.

If the copy needs a binding space, select the book margin mode on the Edit menu.

P.73 “Creating bookbinding margins”

7 Place the original on the original glass.

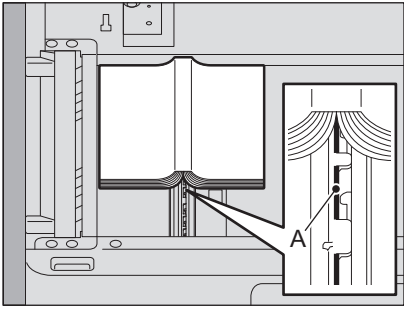

Place the original aligning its center to the “A” portion as shown in the above figure.

⚠ CAUTION

Do not place any heavy objects (4 kg (9 lb.) or over) on the original glass and do not press on it with force. Breaking the glass could injure you.

8 Press the [START] button on the control panel. Once the pages are scanned, set the next ones on the original glass.

Repeat this step until all the desired pages have been scanned. If the last page is a single page, press [Copy Final Page] on the touch panel, and then press the [START] button on the control panel to start scanning. The scanned pages will be copied.

9 When all the pages have been scanned, press [Finished].

The scanned pages will be copied.

Setting Original Modes

You can make copies with the optimal image quality by selecting the following modes for your original. The selectable original mode differs depending on the color mode as shown in the table below. Select the color mode first, and then the original mode.

Original mode	Description	Color mode		
		Full Color	Black	Auto Color
Text/Photo	Originals with text and photographs mixed	Yes	Yes	Yes
Text	Originals with text (or text and line art) only	Yes	Yes	Yes
Printed Image	Originals with photogravure (e.g. magazine, brochure)	Yes	—	Yes
Photo	Originals with general photographs on photographic printing paper	Yes	—	—
	Originals with photographs	—	Yes	—
Map	Originals with fine illustrations or text	Yes	—	—
Image Smoothing	Originals with text and photographs mixed (especially originals requiring higher reproducibility on photos)	—	Yes	—

Tip

Text/Photo is set by default. The default setting can be changed in each color mode. For details, refer to the **MFP Management Guide**.

1 Press [Original Mode] on the Basic menu.

2 Select the original mode, and then press [OK].

The selectable original modes differ depending on the color modes currently set.

Example: When the color mode is “Full Color”

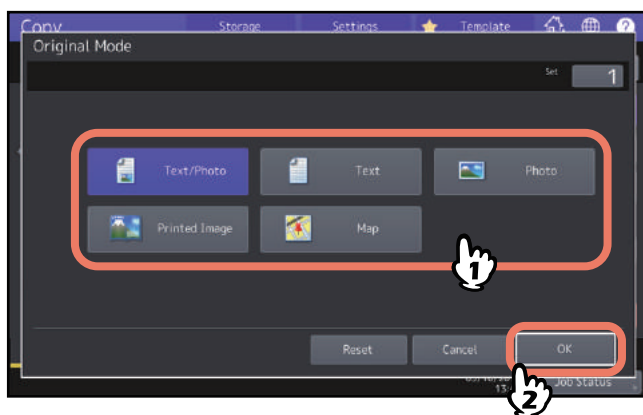

HOW TO USE EDITING FUNCTIONS

This chapter describes how to use various copying functions on the Edit menu.

Displaying the Edit Menu	70
Creating Margins	71
Creating top, bottom, left, and right margins	71
Creating bookbinding margins	73
Copying Multiple Originals onto One Sheet (2 in 1 / 4 in 1)	74
Applying Different Settings for Cover Sheets (Cover Sheet)	77
Inserting a Sheet at a Desired Page (Sheet Insertion)	79
Adding a Date and Time on Copied Paper	82
Adding a Page Number on Copied Paper (Page Number)	83
Editing Scanned Images	84
Trimming and masking.....	84
Mirror image and negative/positive reversal.....	87
Applying Separate Reproduction Ratios to Vertical and Horizontal Directions (XY Zoom)	88
Copying the Same Image Repeatedly on One Sheet (Image Repeat) (Color Model only)	89
Removing Blank Pages While Copying (Omit Blank Page)	91
Clearing Dirty Edges of Originals (Edge Erase)	92
Clearing Shadows in the Center of Book-type Originals (Book Center Erase)	93
Copying the Sides of Book-type Originals Separately (Dual Page)	95
Clearing Dark Parts Outside the Originals (Outside Erase)	97
Applying Multiple Settings (Job Build)	99
Switching Feeding Modes (ADF -> SADF)	102
Reducing Images to Scan the Entire Original, Including the Edges (Full Image)	103
Centering a Scanned Image (Centering Copy)	104

Displaying the Edit Menu

You can display the Edit menu by pressing the [Edit] tab on the touch panel when you want to use various editing functions.

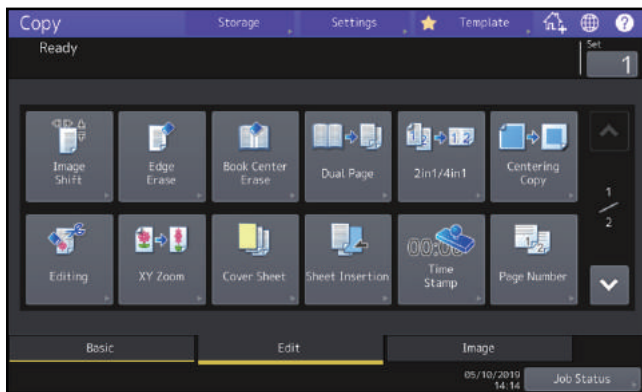
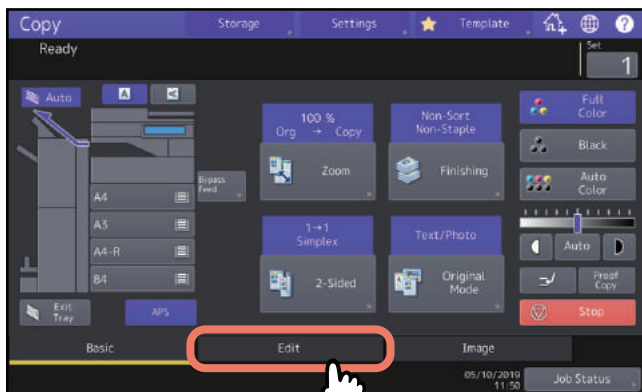

The Edit menu has 2 pages. To switch the pages, press  or .

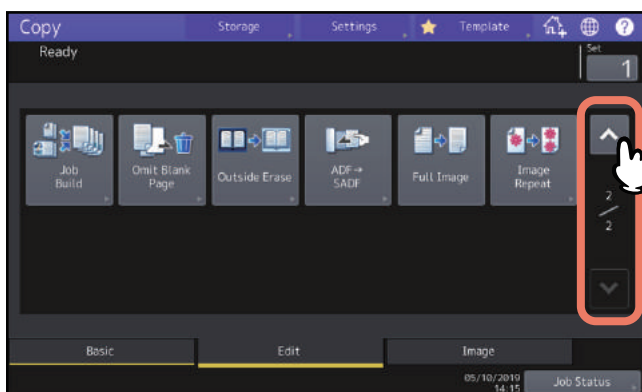

Creating Margins

You can create a binding margin by shifting an image to the left, right, top or bottom of the copy paper. This function is called “image shift”. It is useful when you wish to punch or staple a stack of paper after copying it. With this function you can easily make a binding margin when you copy a book-type original on both sides of the paper.

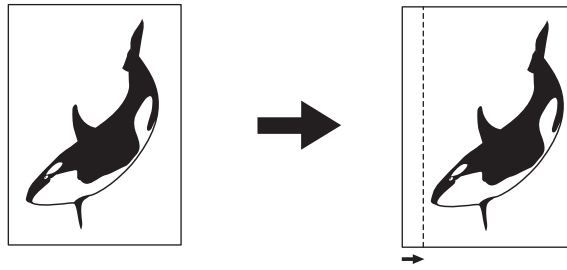

Tip

You can make a binding margin in the combinations as follows:

- Top/bottom margin and left/right margin
- Top/bottom margin and bookbinding margin

■ Creating top, bottom, left, and right margins

- 1 Press [Image Shift] on the Edit menu.
- 2 Select the type of binding margin.

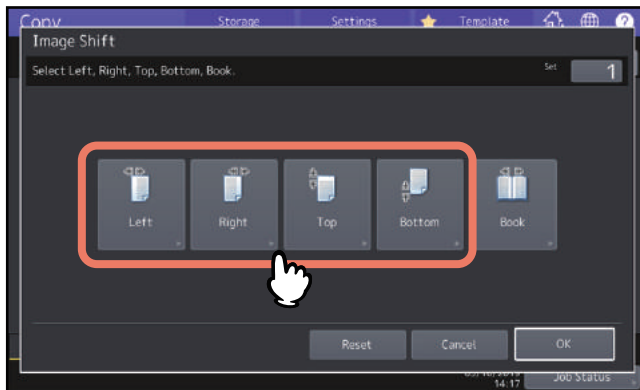

3 Adjust the width of the binding margin, and press [OK].

To adjust the binding margin width, press [Front Margin] and enter the binding margin width on the front side using [▼0 mm] (0") and [▲100 mm] (3.94"). (The width on the back side will be also adjusted in the same way.) When you press [Back Margin] and then adjust the binding margin width on the back side using [▼0 mm] (0") and [▲100 mm] (3.94"), only the width on the back side is adjusted.

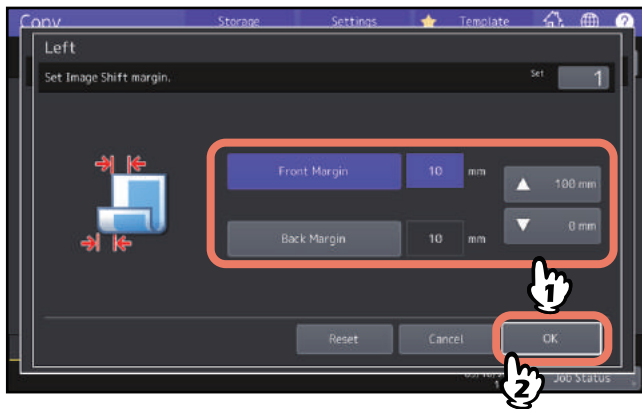

Tip

Note that a margin will be created on the opposite side on the back side of paper in duplex copying.

4 Press [OK].

■ Creating bookbinding margins

You can easily make a binding margin when you copy a book-type original on both sides of the paper.

📖 P.65 “Making a 2-sided copy from a book-type original”

1 Press [Image Shift] on the Edit menu.

2 Press [Book].

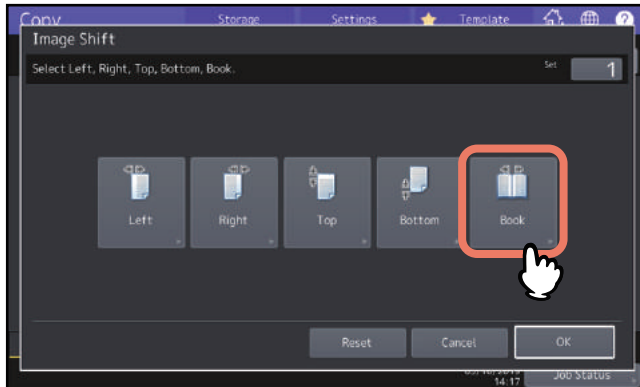

3 Adjust the width of the binding margin, and press [OK].

To adjust the binding margin width, press [▼ 0 mm] (0") and [▲ 30 mm] (1.18") to enter the value.

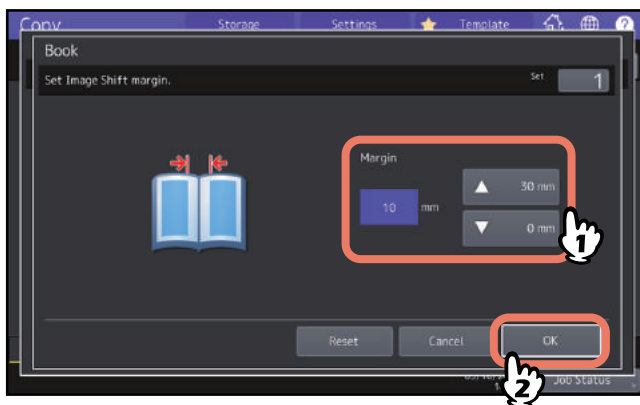

4 Press [OK].

Select the “Book-type original -> 2-sided copy” mode as well.

📖 P.65 “Making a 2-sided copy from a book-type original”

Copying Multiple Originals onto One Sheet (2 in 1 / 4 in 1)

You can copy 2 or 4 originals to 1 sheet of paper by shrinking them. This function is called “2 in 1” or “4 in 1”. If you use this function together with duplex copying, you can make a total of 8 images on 1 sheet of paper.

Confirm both the direction of placing originals and the setting of an original direction.

☞ P.26 “Specifying the orientation of originals”

You can change default settings for an original direction for 2 in 1 / 4 in 1. For changing the settings, refer to the **MFP Management Guide**.

The following illustrations are shown as an example of setting combinations.

2 in 1

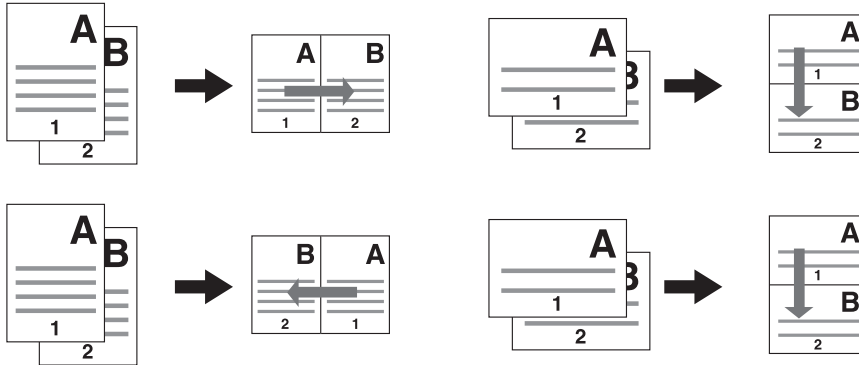

4 in 1

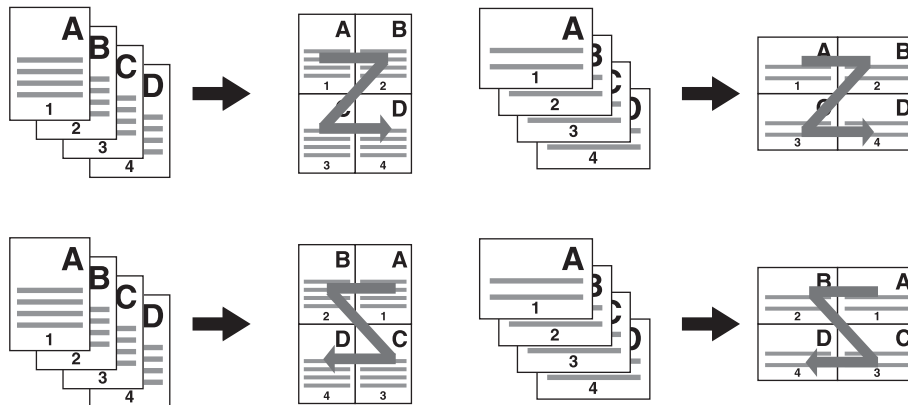

2 in 1 & duplex copying (Tablet)

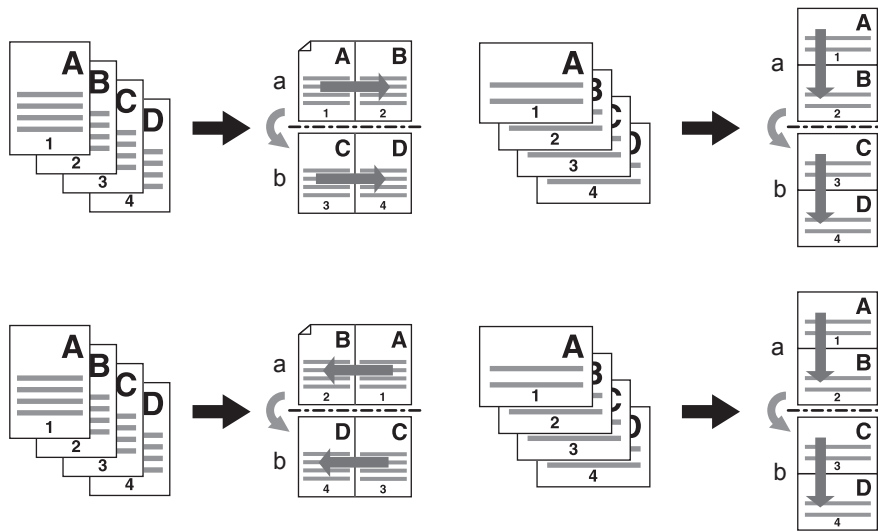

4 in 1 & duplex copying (Book)

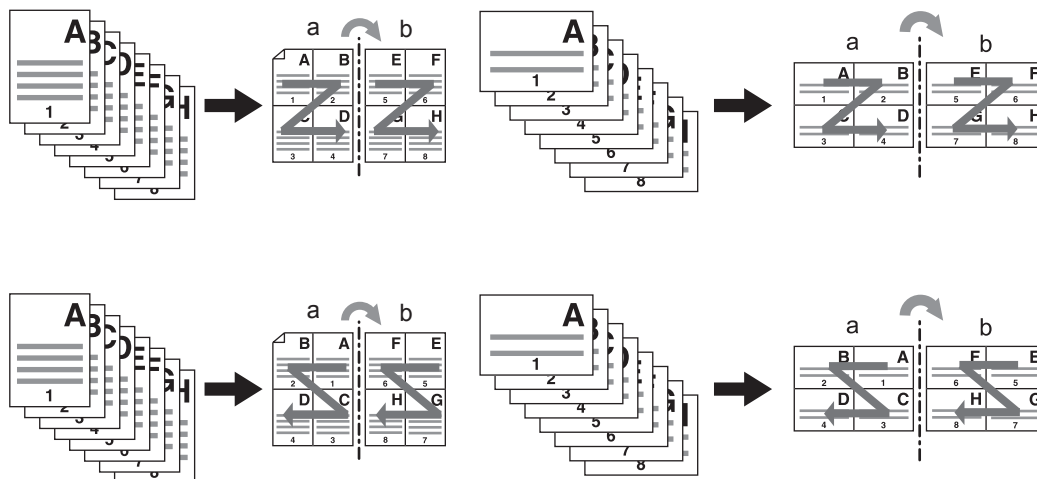

Tip

If you select paper of a different size to that of the original, press [Zoom] on the Basic menu. Next select the desired paper size, press [AMS] and then [OK] in the menu shown below.

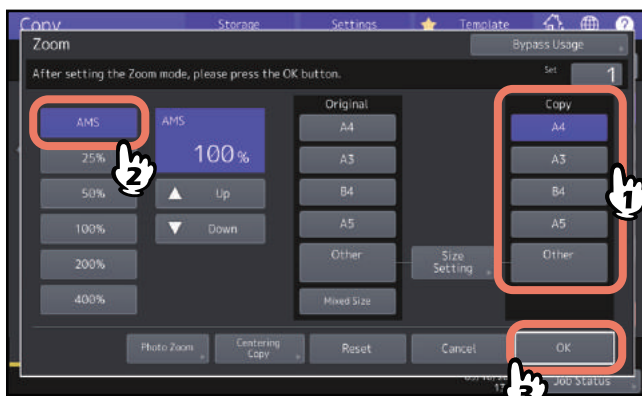

1 Press [2 in 1 / 4 in 1] on the Edit menu.

2 Perform 2 in 1 / 4 in 1 setting, and press [OK].

If you want to copy 2 originals on 1 page, select [2 in 1]. If you want 4 on 1 page, select [4 in 1].
Select an arrangement order of pages with the button in the menu of Direction.
Select [Original Direction] according to the placed original.
To perform duplex copying, select the duplex mode.

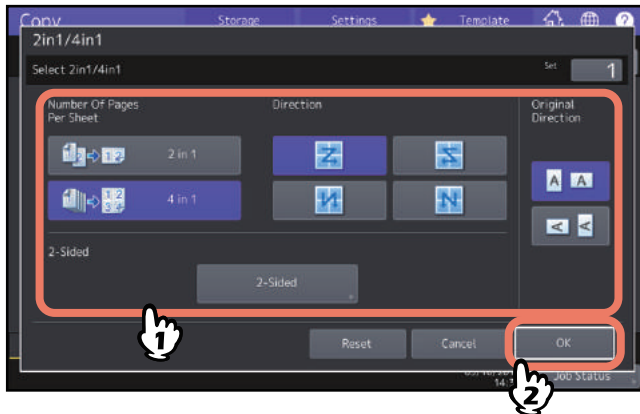

Tip

- Specify the appropriate orientation and the page direction settings for the placed original. If the setting does not match the actual orientation of the original, it will be printed in an unintended direction.
- “Original Direction” can be set on the Copy menu.
📖 P.13 “Equipment status indication area”
- For details on the duplex copying mode, refer to the following page.
📖 P.62 “Duplex Copying”

Applying Different Settings for Cover Sheets (Cover Sheet)

You can add a special type of paper such as colored paper as a front cover sheet or a back cover sheet. This function is called “cover sheet”. In the cover sheet mode, you can select whether or not to copy the front or back cover sheet as shown in the table below.

Front cover		Back cover	
Mode	Description	Mode	Description
None	Does not add a sheet as the front cover	None	Does not add a sheet as the back cover
Blank	Adds a blank sheet as the front cover	Blank	Adds a blank sheet as the back cover
Top Copied	Adds a sheet copied on the top side as the front cover	Top Copied	Adds a sheet copied on the top side as the back cover
Both Copied	Adds a sheet copied on both sides as the front cover	Both Copied	Adds a sheet copied on both sides as the back cover
		Only Back Copied	Adds a sheet copied on the back side as the back cover

Example: Selecting “Top Copied” for the front cover and “Blank” for the back cover

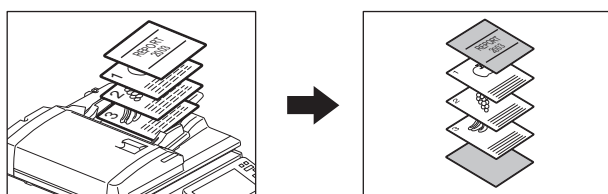

A sheet copied on the top is added as the front cover and a blank sheet as the back cover.





1 Place the paper for the cover sheets and specify the paper type.

Place it on the bypass tray or in a drawer previously set for cover sheets. The paper for the cover sheets must be placed in a different paper source than normal paper.

Note

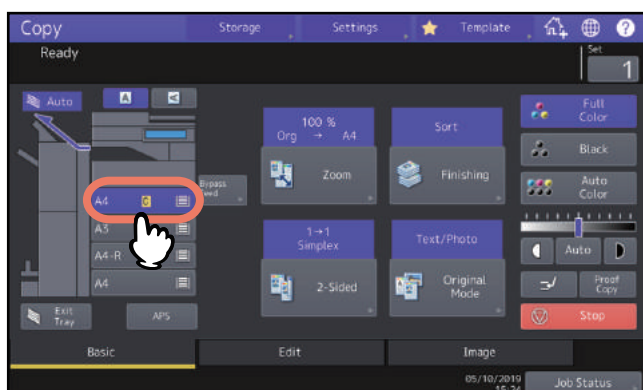
- When placing paper in a drawer for cover sheets, be sure to select “Cover” as the paper type, and also set the paper size and thickness.  appears when “Cover” is selected as the paper type for a drawer.
 P.31 “Specifying the Paper Type”



- When placing paper on the bypass tray, be sure to set the paper size and thickness.
 P.32 “Bypass Copying”
- Place the paper for cover sheets of the same size as normal paper in the same direction.

2 Place the normal paper in the drawer(s).

3 Place the original(s).

When placing them on the original glass, they must be placed from the first page.

4 Press [Cover Sheet] on the Edit menu.

5 Select the front and back cover settings, and then press [OK].

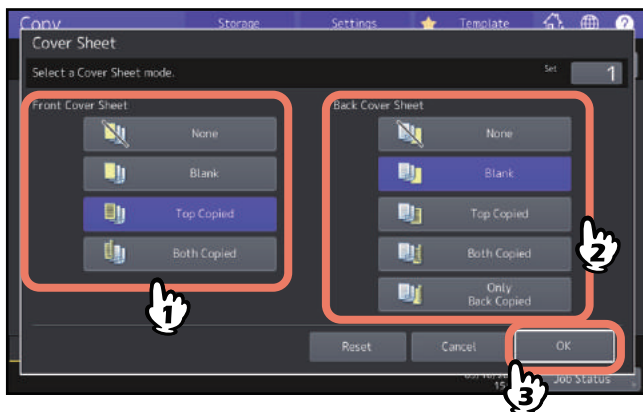

Tip

You can select [Both Copied] for the front or back cover sheet only when [1->2 Duplex] or [2->2 Duplex] is set for the 2-sided copy mode on the basic menu.

6 Press the [Basic] tab to display the Basic menu. Then select a drawer in which normal paper is placed (not the one for the cover sheets).

You must place the normal paper of the same size and direction as that for the cover sheets in advance.

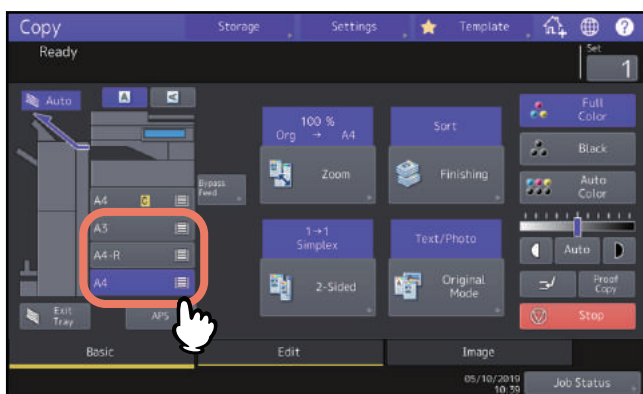

7 Select other copy modes as required, and then press the [START] button on the control panel.

When the originals are placed on the ADF, scanning and copying start.

When they are placed on the original glass, follow steps 8.

8 Place the next original, and then press [Next Copy] on the touch panel or the [START] button on the control panel.

Scanning of the next original starts. Repeat this procedure until the scanning of all the originals is finished.

Inserting a Sheet at a Desired Page (Sheet Insertion)

You can insert a special type of paper such as colored paper at the desired page. This function is called “sheet insertion”. You can insert up to 2 types of sheets for a total of 50 pages. The sheet insertion mode has the following 2 types:

Copied: Inserts a copied sheet, replacing the specified page.

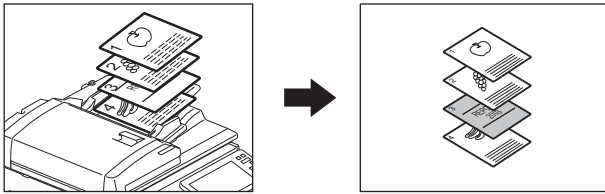

Blank: Inserts a blank sheet before the specified page.

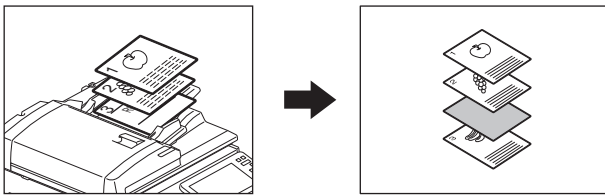

1 Place sheets for sheet insertion and specify the paper type.

Place them on the bypass tray or in a drawer previously set for insertion sheets. The paper for the insertion sheets must be placed in a different paper source than normal paper.

Note

- When placing paper in a drawer for sheet insertion, be sure to select “INSERT 1” or “INSERT 2” as a paper type, and also set the paper size and thickness. **[I1]** or **[I2]** appears when “Insert” is selected as the paper type for a drawer.

P.31 “Specifying the Paper Type”

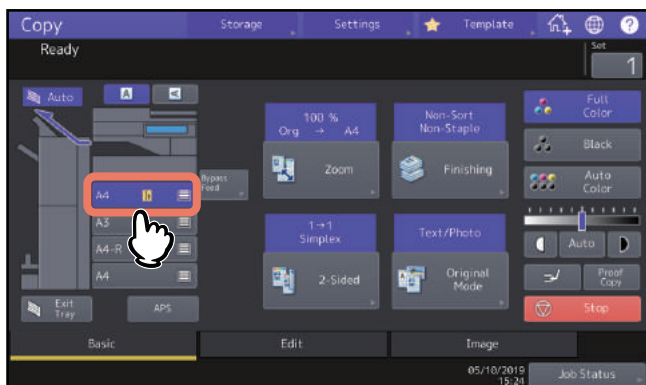

- When placing paper on the bypass tray, be sure to set the paper size and thickness. P.32 “Bypass Copying”
- Place the paper for insertion sheets of the same size as normal paper in the same direction.

2 Press [Sheet Insertion] on the Edit menu.

3 Select either [Copied] or [Blank].

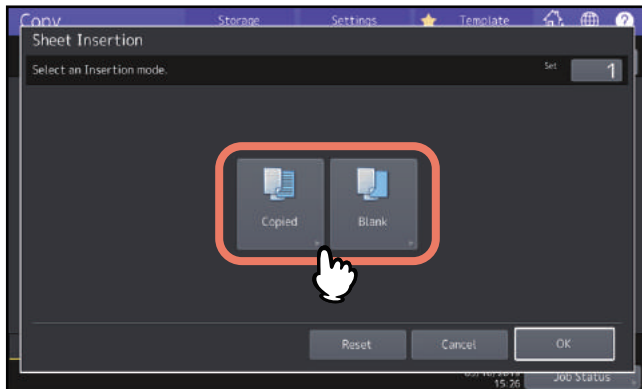

4 Select the page where the insertion sheets will be inserted, and press [OK].

Enter page numbers (1 to 1000) where the insertion sheets will be inserted, and then press [Set]. Repeat this step if you want to insert sheets at more than one page.

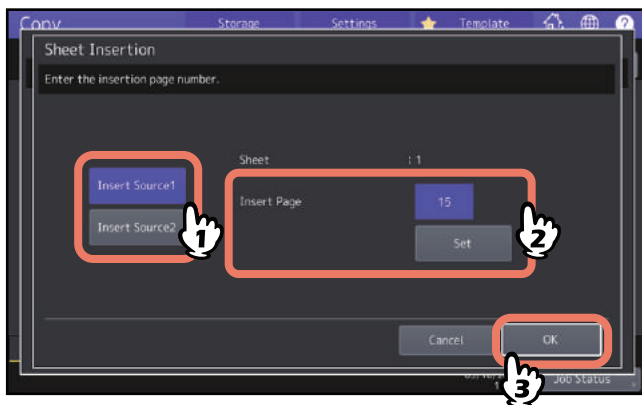

Tip

- If you selected [Copied] in step 3, the selected page will be replaced with a copied insertion sheet. If you selected [Blank], a blank insertion sheet will be inserted before the selected page.
- Up to 50 pages in total can be selected for [Insert Source 1] and [Insert Source 2].

5 Press the [Basic] tab to display the Basic menu. Then select the drawer in which normal paper is placed (not the one for sheet insertion).

You must place the normal paper of the same size and direction as that for the insertion sheets in advance.

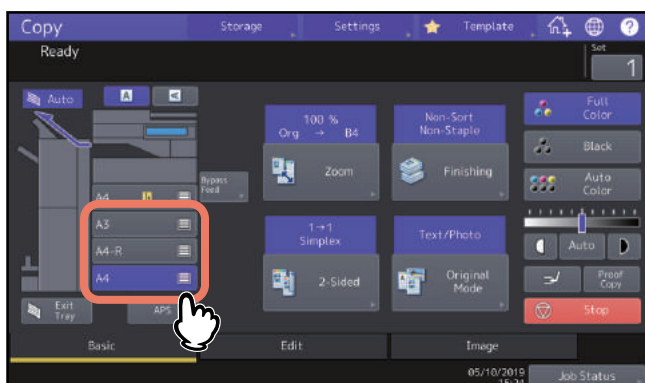

-
- 6 Select other copy modes as required, and then press the [START] button on the control panel.**
When the originals are placed on the ADF, scanning and copying start.
When they are placed on the original glass, follow steps 7 and 8.
 - 7 Place the next original, and then press [Next Copy] on the touch panel or the [START] button on the control panel.**
Scanning of the next original starts. Repeat this procedure until the scanning of all the originals is finished.
 - 8 When the scanning of all the originals is finished, press [Job Finish] on the touch panel.**
Copying starts.

Adding a Date and Time on Copied Paper

You can add the date and time on the copied paper.

Printed at the bottom
of a portrait copy

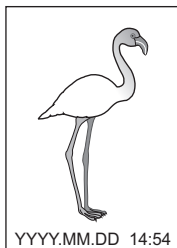

Printed at the top
of a landscape copy



- 1 Press [Time Stamp] on the Edit menu.**
- 2 Select the direction and position of the time stamp, and press [OK].**

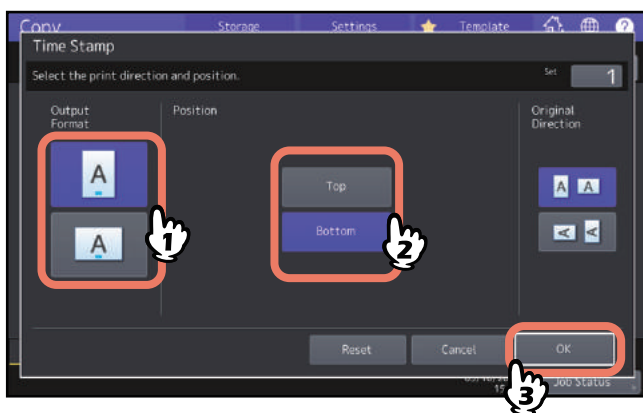

Adding a Page Number on Copied Paper (Page Number)

You can add a page number on the copied paper.

Printed at the bottom center of a portrait copy

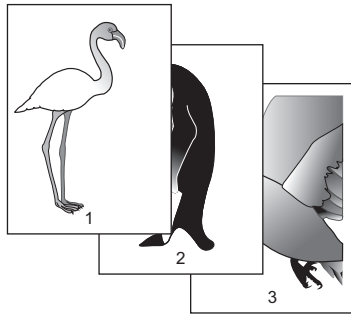

Printed at the top right of a landscape copy

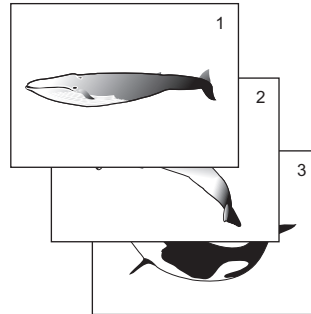

- 1 Press [Page Number] on the Edit menu.
- 2 Select the direction and position of a page number.
If you want to specify the page number to start with, press  and go to step 3.

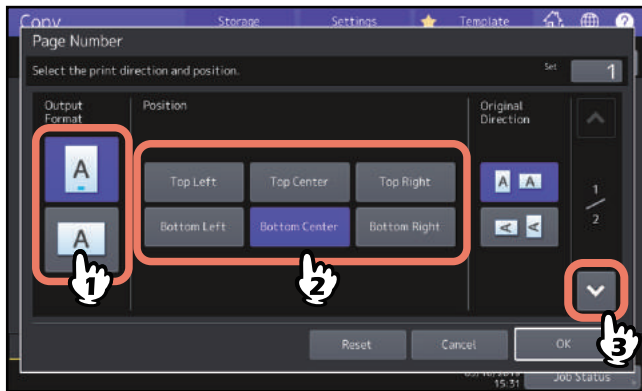

- 3 Specify the start page and the page number you want to start with, and press [OK].

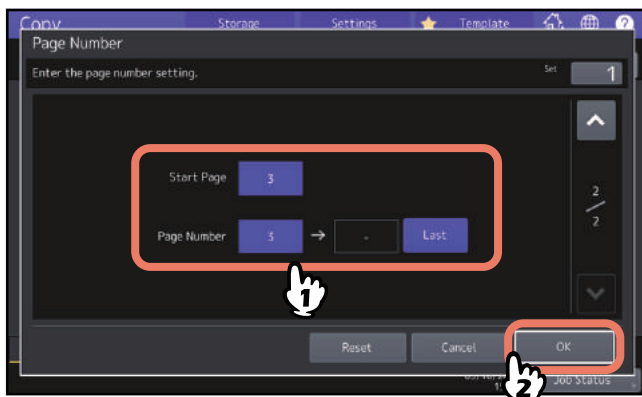

Tip

You can specify the start page from 1 to 1000 (2000 for some models).
You can specify the page number from 1 to 32766.

Editing Scanned Images

You can select the various editing functions shown below for scanned images.

Trimming: You can select a certain area of an original and copy only the selected area.

Masking: You can mask a certain area of an original and copy only the unmasked area.

Mirror image: You can reverse an image like a mirror.

Negative/Positive reversal: You can reverse the light-and-dark of an image.

■ Trimming and masking

You can select the desired area of an original and copy only the selected area (trimming). You can also mask the desired area of an original and copy only the unmasked area (masking). On both functions you can select up to 4 areas on 1 original. The selected area should be in a rectangle.

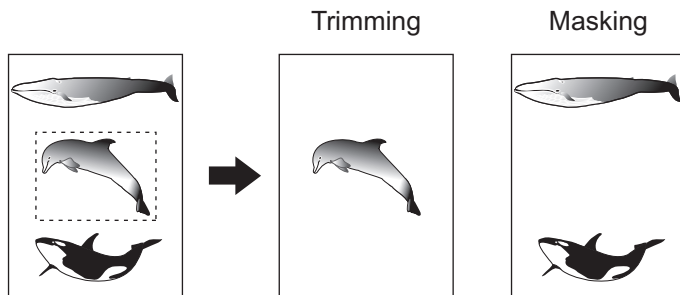

Tip

- Only standard size originals are applicable.
- Note that the entire image of the selected area may not be copied if you do not select proper sizes for the original and copy paper.

1 Press [Editing] on the Edit menu.

2 Select [Trim] or [Mask].

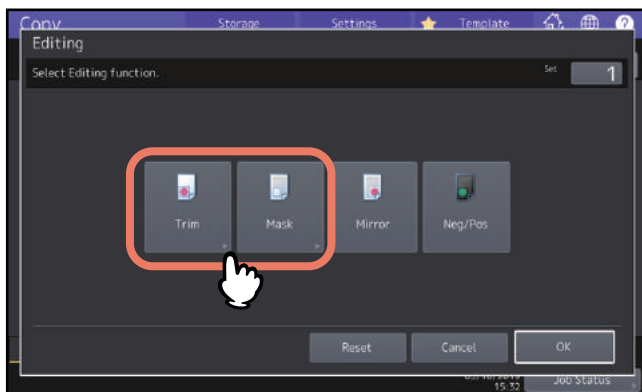

3 Place the original on the original glass with its face up.

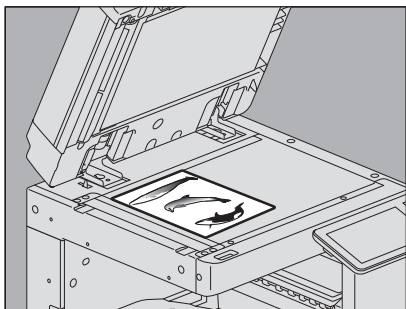

Place it with its bottom toward you. Align its top left corner against that of the original glass so that the original will be aligned with the original scales.

⚠ CAUTION

Do not place any heavy objects (4 kg (9 lb.) or over) on the original glass and do not press on it with force. Breaking the glass could injure you.

4 Read the following 4 values to specify the area using the left and top scales on the original glass.

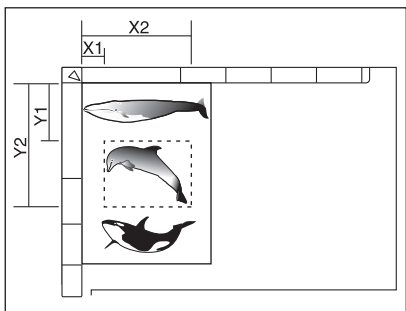

- **X1:** From the top left to the left edge of the selected area
- **X2:** From the top left to the right edge of the selected area
- **Y1:** From the top left to the upper edge of the selected area
- **Y2:** From the top left to the lower edge of the selected area

Note that the marks of the original scales have a 2 mm (0.08") pitch.

5 Key in the read values, and press [OK].

You can specify up to 4 areas on 1 page. When you want to specify more than one area, press [Area 1] to [Area 4] to switch the area, and then key in the values correspondingly.



6 Place the original again on the original glass with its face down.

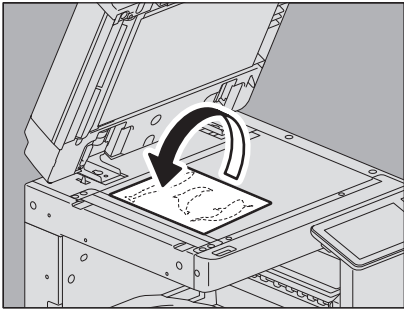

Place it with its bottom toward you. Align its top left corner against that of the original glass.

■ Mirror image and negative/positive reversal

You can reverse an image like a mirror (mirror image), or you can reverse light-and-dark of an image (negative/positive reversal).

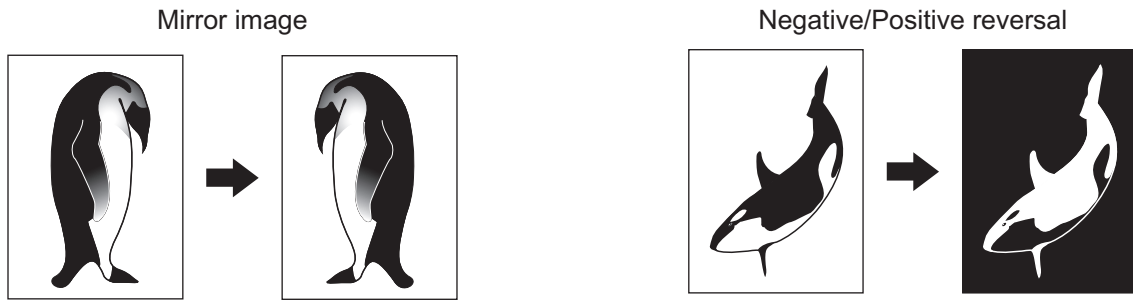

Note

Negative/positive reversal is available only when Black or Full Color is selected as a color mode.

- 1 Press [Editing] on the Edit menu.
- 2 Select [Mirror] or [Neg/Pos], and then press [OK].

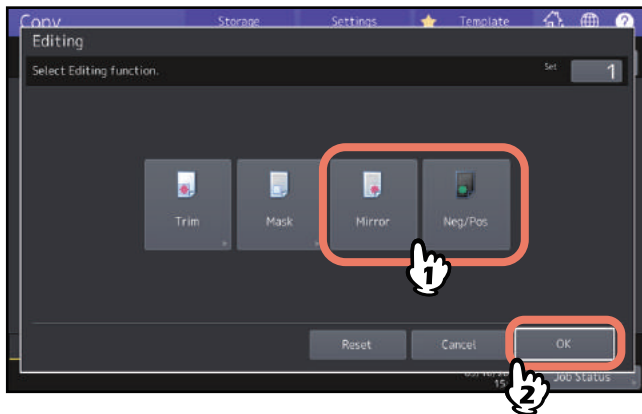

Applying Separate Reproduction Ratios to Vertical and Horizontal Directions (XY Zoom)

You can change the reproduction ratio in both vertical and horizontal directions separately. This function is called “XY zoom”.



Note

The reproduction ratio is changeable from 25 to 400%. However in the following cases, this range is 25 to 200%.

- When the color mode is Full Color or Auto Color
- When the original mode is Image Smoothing
- When the color mode is Black and the original mode is Photo
- When Twin Color Copy is selected
- When Mono Color is selected
- When the original is placed on the ADF

1 Press [XY Zoom] on the Edit menu.

2 Set the reproduction ratio in both vertical and horizontal directions.

For a horizontal direction, press [X], and then press either [▼25%] or [▲400%].

For a vertical direction, press [Y], and then press either [▼25%] or [▲400%].

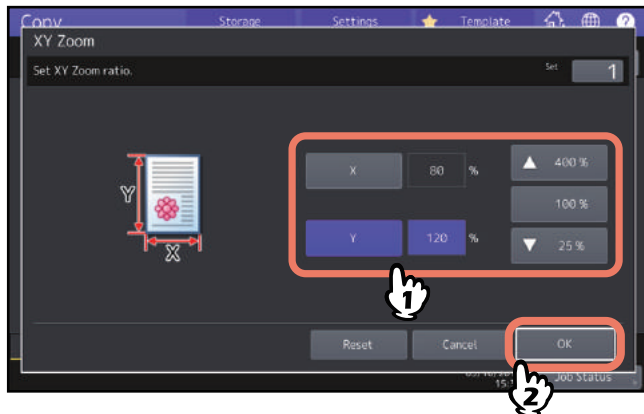

Tip

Regardless of an original direction, enter the original width in [X] and the original length in [Y] viewed from the front of the equipment.

Copying the Same Image Repeatedly on One Sheet (Image Repeat) (Color Model only)

You can copy a certain area on an original repeatedly in the times that you specified. This function is called “image repeat”.

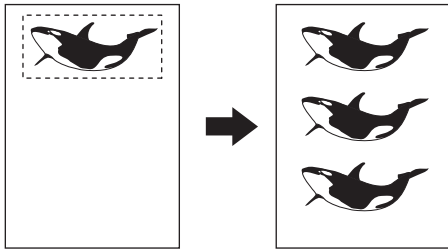

Note

When registering this function into a template, be sure to select [Disable] of “Automatic Start”. If [Enable] is selected, copies may not be made correctly because the original size is not detected.

Tip

- You can repeat copying up to 8 times.
- Only standard size originals are available.

1 Press [Image Repeat] on the Edit menu.

2 Place the original on the original glass with its face up.

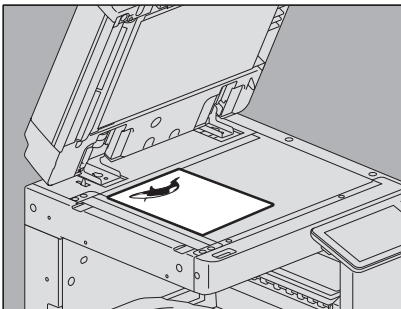

Place it with its bottom toward you. Align its top left corner against that of the original glass so that the original will be aligned with the original scales.

⚠ CAUTION

Do not place any heavy objects (4 kg (9 lb.) or over) on the original glass and do not press on it with force. Breaking the glass could injure you.

3 Read the following 4 values to specify the area using the left and top scales on the original glass.

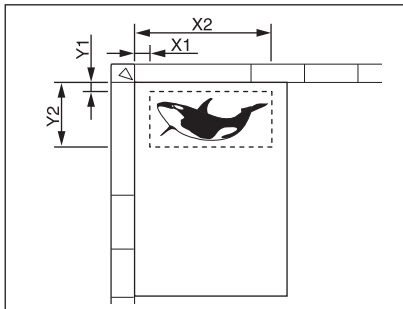

- **X1:** From the top left to the left edge of the selected area
- **X2:** From the top left to the right edge of the selected area
- **Y1:** From the top left to the upper edge of the selected area
- **Y2:** From the top left to the lower edge of the selected area

Note that the marks of the original scale have a 2 mm (0.08") pitch.

4 Key in the read values and specify the repeat count, and press [OK].

When you want to change the number of times you repeat the image (repeat count), press either [▼2] or [▲8].

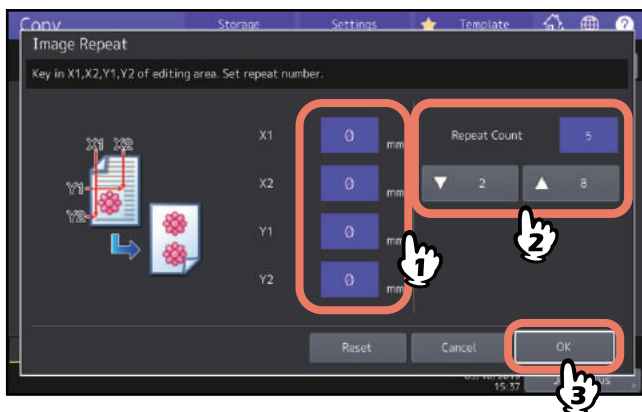

Note

- The selected area will be copied from the top right corner in a vertical direction.
- If the repeated image runs over the paper size, that part will not be copied.

5 Place the original again on the original glass with its face down.

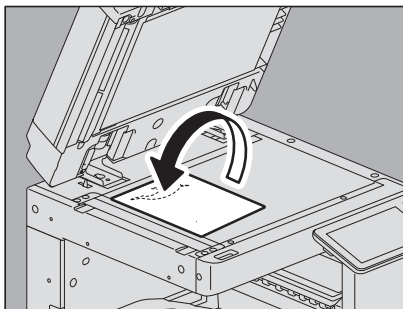

Place with its bottom toward you. Align its top left corner against that of the original glass. When you place the original in a landscape direction, place it with its top pointing to the left edge of the original glass.

Removing Blank Pages While Copying (Omit Blank Page)

You can remove blank sheets included in the scanned originals before copying is started. This function is called “omit blank page”.

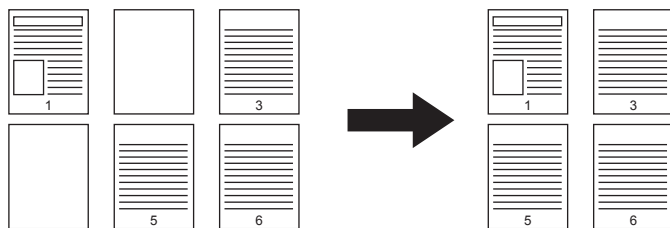

Note

- This function may not properly detect blank sheets included in the following types of originals:
 - Half-tone originals
 - Originals including sheets almost blank (e.g. blank pages having only page numbers)
- If you copy 2-sided originals including blank sheets to 2-sided copy while this function is enabled, the front and back sides of the originals and the copies will not match.

Tip

The sensitivity to detect blank pages can be changed. For details, refer to the *MFP Management Guide*.

1 Press [Omit Blank Page] on the Edit menu.

2 Press [OK].
Omit blank page is now set.

Clearing Dirty Edges of Originals (Edge Erase)

You can whiten the edge of the copied image when a shadow-like dark part appears on it. This function is called “edge erase”. It is useful when you want to make the copied image neat and clear if the edge of the original is dirty or torn.

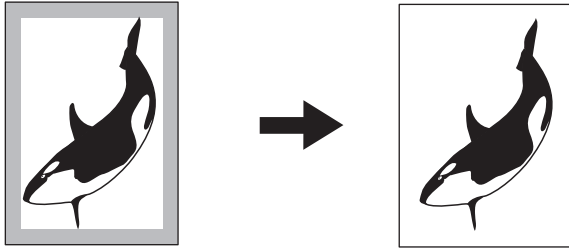

Tip

Only standard size originals are applicable.

- 1 Press [Edge Erase] on the Edit menu.**
- 2 Adjust the width of the part to be erased, and press [OK].**
Press either [▼ 2 mm] (0.08") or [▲ 50 mm] (1.97").

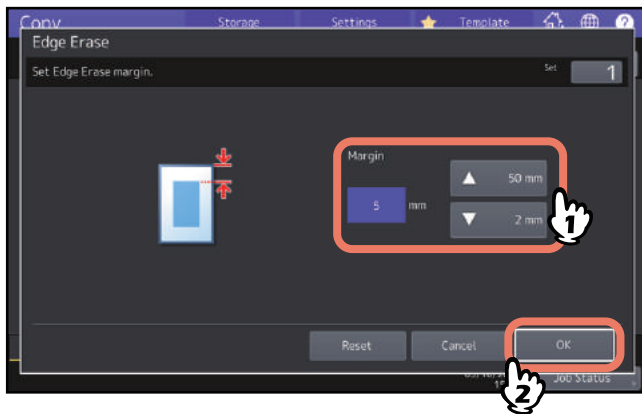

Clearing Shadows in the Center of Book-type Originals (Book Center Erase)

You can whiten the center of the copied image when a shadow-like part appears on it.

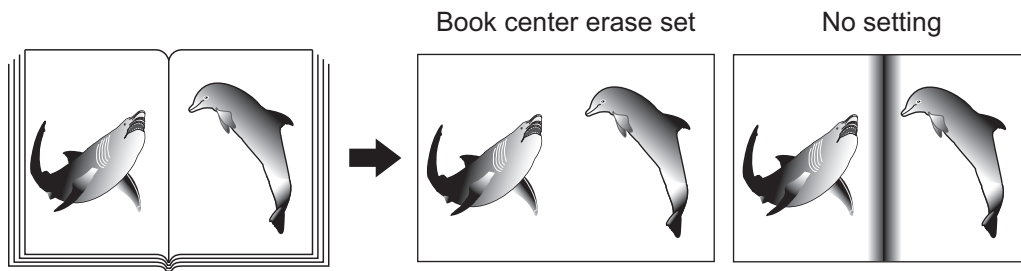

1 Select the drawer for the desired paper size.

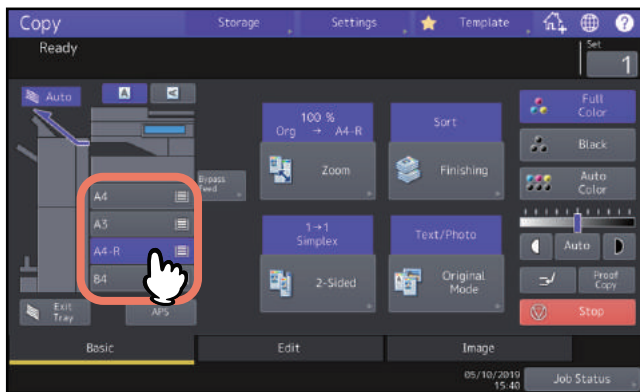

2 Press [Book Center Erase] on the Edit menu.

3 Adjust the width of the part to be erased, and press [OK].

Press either [▼ 2 mm] (0.08") or [▲ 50 mm] (1.97").

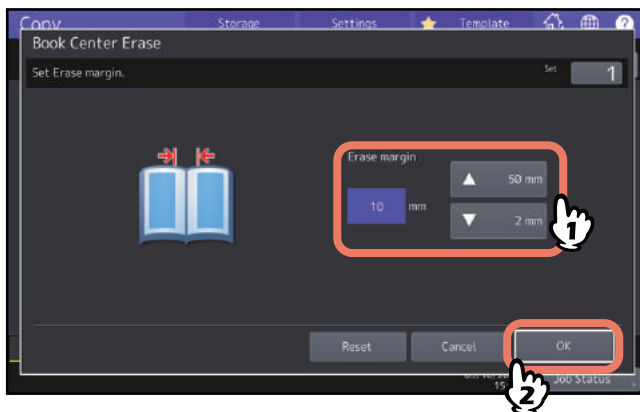

4 Place the original on the original glass.

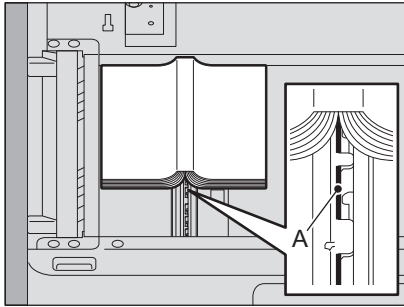

Place the original aligning its center to the “A” portion as shown in the above figure.

⚠ CAUTION

Do not place any heavy objects (4 kg (9 lb.) or over) on the original glass and do not press on it with force. Breaking the glass could injure you.

Copying the Sides of Book-type Originals Separately (Dual Page)

You can copy the 2 facing pages of a book-type original or 2 original sheets placed side by side onto 2 separate sheets of paper or on both sides of 1 sheet of paper. This function is called “dual page”. You do not have to shift the original on the original glass. You can also copy two originals in the same size (A4 or B5) placed side by side individually on two separate sheets of paper.

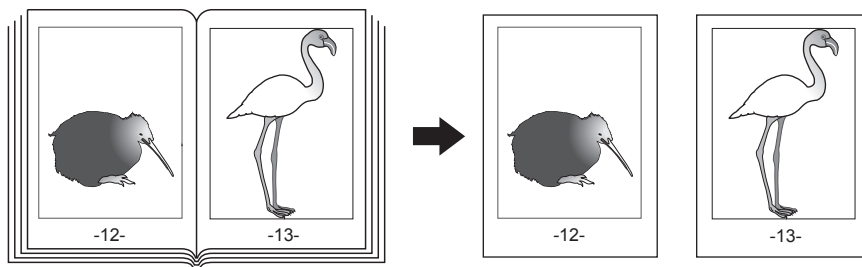

Tip

Only A4, B5 and LT sizes are applicable.

1 Press [Dual Page] on the Edit menu.

2 Press [1 Side] or [2 Side].

1 Side: Copying the 2 facing pages of the original to only 1 side of 2 separate sheets of paper

2 Side: Copying the 2 facing pages of the original to 2 sides of 1 sheet of paper

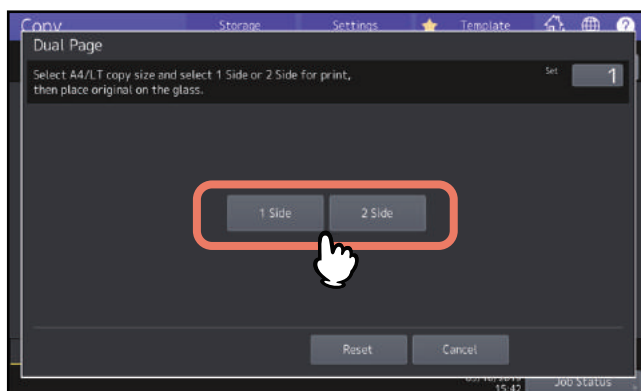

3 Select other copy modes as required.

You can select “image shift” as well.

P.71 “Creating top, bottom, left, and right margins”

4 Press the [Basic] tab to display the Basic menu, and then select A4, B5 or LT as the copy paper size.

When using bypass copying, be sure to set the paper size.

5 Open the desired page of the original and place it on the original glass.

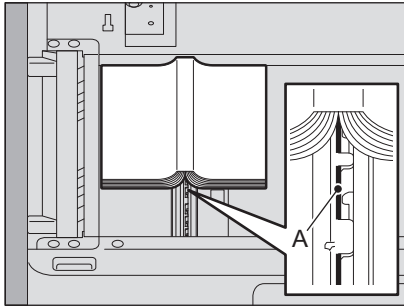

Place the original aligning its center to the “A” portion as shown in the above figure.

⚠ CAUTION

Do not place any heavy objects (4 kg (9 lb.) or over) on the original glass and do not press on it with force. Breaking the glass could injure you.

6 Press the [START] button on the control panel. When the scanning of the opened pages is finished, open the next pages and place them.

Repeat this procedure until all the desired pages have been scanned. If the last page is a single page, press [Copy Final Page] on the touch panel, and then press the [START] button on the control panel to start scanning. The scanned pages will be copied.

7 When all the pages have been scanned, press [Finished].

The scanned pages will be copied.

Clearing Dark Parts Outside the Originals (Outside Erase)

You can whiten a shadow-like dark part which has appeared outside of the copied image; this has been caused by a gap between the original glass and the platen sheet. This function is called “outside erase”. It is useful when you place thick originals such as booklets on the original glass.

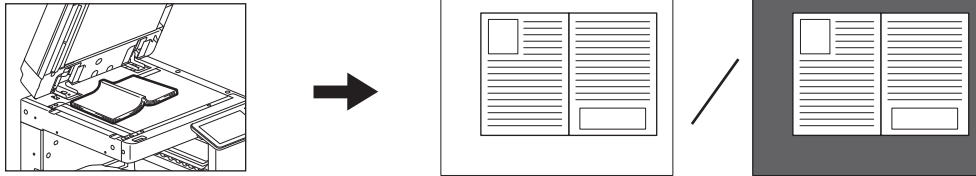

Note

- This function is disabled when you place originals on the ADF or you place them on the original glass with the ADF or the Original Cover closed fully.
- When this function is enabled, the automatic density adjustment is disabled. Adjust the density level manually.
- When you copy an original such as one cutout into an intricate shape or one having darker images on its edge, the border of such original may not be properly detected.

1 Select the drawer for the desired paper size.

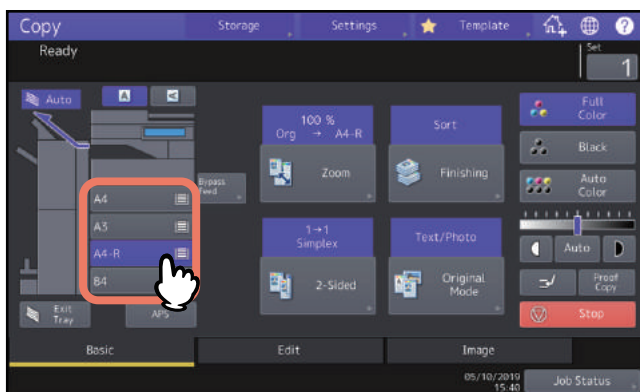

2 Press [Outside Erase] on the Edit menu.

3 Set “outside erase”, and press [OK].

Press [On], and adjust the width of the border around the original by pressing either **-** or **+** as required. When you adjust it to the **+** side, the area to be detected as not belonging to the original is widened. When you adjust it to the **-** side, the area to be detected as not belonging to the original is narrowed.

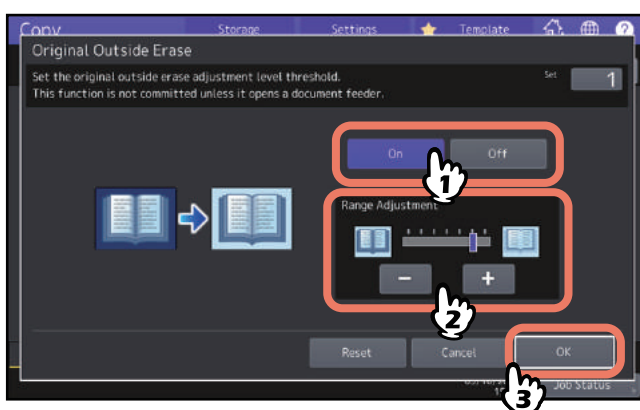

4 Place the original on the original glass.

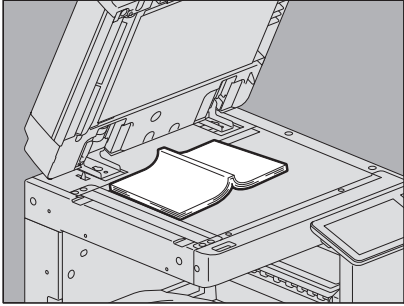

Press [Zoom] and set the size of the original.

 P.45 “Specifying both the original size and the copy paper size separately”

Note

- When placing the original, be sure that the Original Cover, the ADF is fully raised. If not, this function may not properly be able to detect the border between the original and areas not belonging to it.
- Do not directly look at the original glass during copying since an intense light may leak.

CAUTION

Do not place any heavy objects (4 kg (9 lb.) or over) on the original glass and do not press on it with force. Breaking the glass could injure you.

Applying Multiple Settings (Job Build)

You can scan several stacks of originals whose settings are individually different with different devices (ADF or original glass), and then copy or store them in one operation. This function is called “job build”. For example, news clips (in the Text mode) and photographs in magazines (in the Photo mode) in A3 size and photographs in A4 size can be scanned in the optimal settings for each, and copied in one operation.

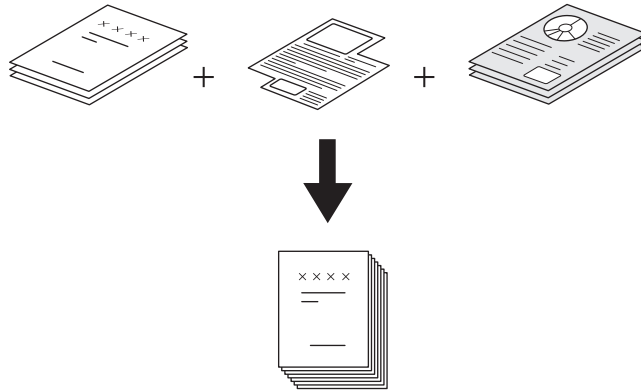

Note

- Up to 1000 pages of originals can be copied in one operation. There is no limit for the number of jobs.
- Some settings are not available for job build, and some settings for the first job will be applied to all of the other jobs. See the table below before setting job build.

Settings not available	Settings applied for all jobs	Settings changeable for each job
Automatic Paper Selection Book -> 2 (Book-type original -> 2-sided copy) Twin color copying Editing XY zoom Cover sheet Sheet insertion Magazine sort Magazine sort & saddle stitch 2 in 1 / 4 in 1 Full image Image repeat	e-Filing / File Mixed-size originals Copy paper size Finishing mode Photo zoom Image shift Book center erase Time stamp Page number Image direction Book - tablet Omit blank page	Reproduction ratio Automatic Magnification Selection (Default setting for job build) Original size Original mode Color mode Simplex/Duplex copying settings other than Book-type original -> 2-sided copy (1->1 Simplex, 2->1 Split, 1->2 Duplex, 2->2 Duplex) Background adjustment Sharpness Edge erase Dual page Document feeder (Feeding mode) Outside erase Drop Out Color

1 Press [Job Build] on the Edit menu.

2 Press [OK].

Job build is now set and the message below appears.

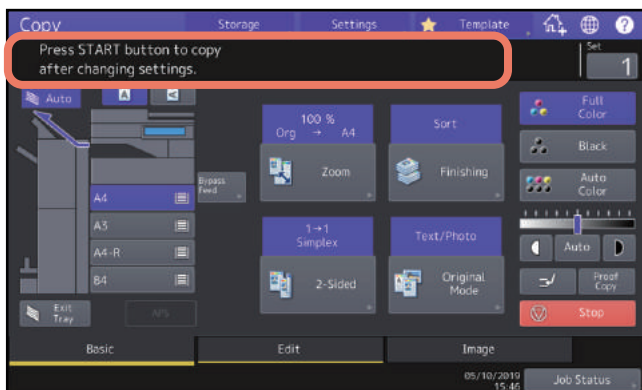

3 Place the first stack of originals, and then select settings.

Note

- Press [Settings] on the touch panel to confirm the current settings.
- If you want to change the settings, press the [FUNCTION CLEAR] button on the control panel, and then restart the procedure from step 1.

Tip

- When placing the original on the original glass, remember that 1 page is equal to 1 job.
- When placing mixed-size originals on the ADF, see the following page:
[P.29 “Copying mixed-size originals in one operation”](#)
- If you want to use a particular drawer, select it.

4 Press the [START] button on the control panel.

Scanning starts. When the scanning of all the originals is finished, the message below appears.

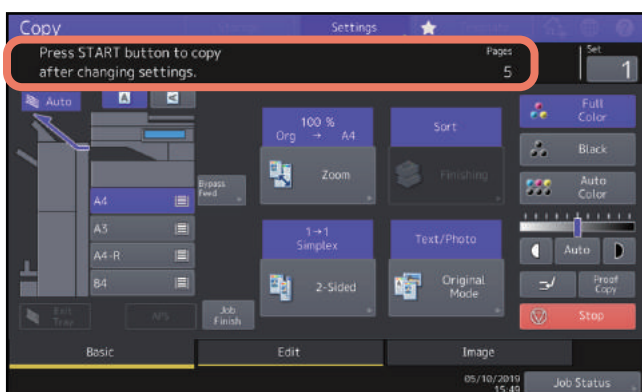

5 Place the next stack of originals, and then select the settings.

Repeat steps 4 and 5 until all the desired pages have been scanned.

Note

If you do not change any settings, those for the last job will be applied.

6 When the scanning of all the originals is finished, change the number of copy sets as required. Then press [Job Finish] on the touch panel.

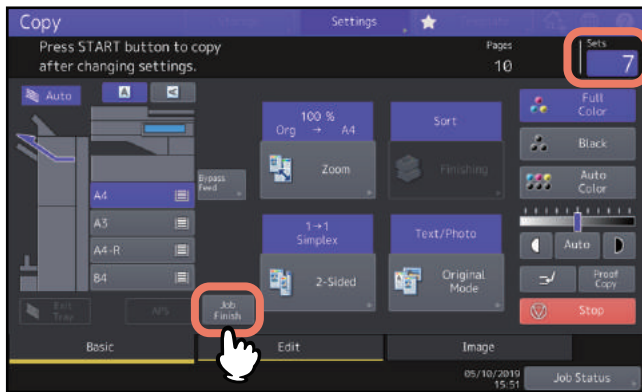

Copying starts. If any storing function is set, that will also start.

Switching Feeding Modes (ADF -> SADF)

You can switch the feeding mode when the ADF is used, from “ADF” to “SADF”. The paper feeding mode has 2 types as follows:

- **ADF (Continuous feed mode):** Feeds originals continuously when you press the [START] button on the control panel while originals are being placed on the ADF. This is useful when you make more than one copy in one operation. (Default setting)
- **SADF (Single feed mode):** Feeds originals one by one automatically. This is useful when you usually only have 1 original.

Note

When the single feed mode (SADF) is set, place originals one sheet at a time. If you place more than one original, the copied image may be skewed or the originals may misfeed.

- 1 Press [ADF -> SADF] on the Edit menu.**
- 2 Press [OK].**
The feeding mode is now set at “single feed mode”.

Reducing Images to Scan the Entire Original, Including the Edges (Full Image)

To learn more about this feature, see the following page:

 P.52 “Reducing images to scan the entire original, including the edges (Full Image) (Color Model only)”

Centering a Scanned Image (Centering Copy)

You can make a copy with a scanned image moved to the center of the paper.

- 1 Press [Centering Copy] on the Edit menu.**
- 2 Press [OK].**

Tip

You can also make a copy with scanned images reduced and moved to the center of the paper.

 P.53 “Reducing and Centering an Image (Centering Copy)”

USING IMAGE ADJUSTMENT FUNCTIONS

This chapter describes the image adjustment functions allowing you to change the overall color balance of a copied image, copy an original in a specified color, and so on.

Displaying the Image Menu	106
Adjusting Color Balance (CMYK adjustment) (Color Model only).....	107
Canceling color balance adjustment	107
Adjusting RGB (Color Model only).....	108
Canceling RGB adjustment.....	108
Adjusting the Image Quality with One Touch (Color Model only)	109
Canceling one-touch adjustment	109
Avoiding Bleed-through (Background adjustment).....	110
Canceling background adjustment.....	110
Adjusting the Sharpness	111
Canceling sharpness adjustment.....	111
Applying Twin Color Copying (Color Model only)	112
Copying in black and specified color	112
Copying in red and black.....	115
Applying Mono Color Copying (Color Model only)	117
Canceling mono color copying.....	117
Adjusting the Hue (Color Model only)	118
Canceling hue adjustment	118
Adjusting the Saturation (Color Model only)	119
Canceling saturation adjustment	119
Reducing the Scan Noise	120
Canceling the ADF scan noise reduction	120
Copying black images only (Color Model only)	121

Displaying the Image Menu

You can display the Image menu by pressing the [Image] tab on the touch panel when you want to use various image adjustment functions.

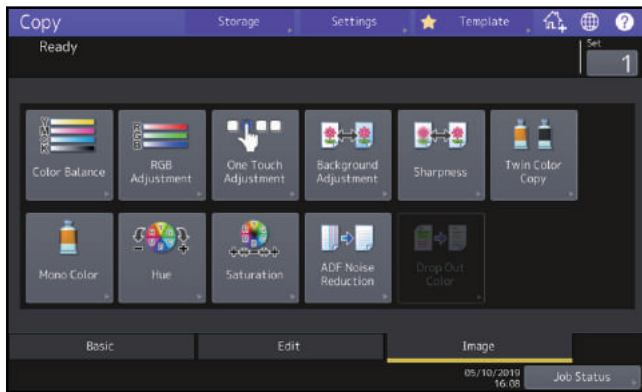
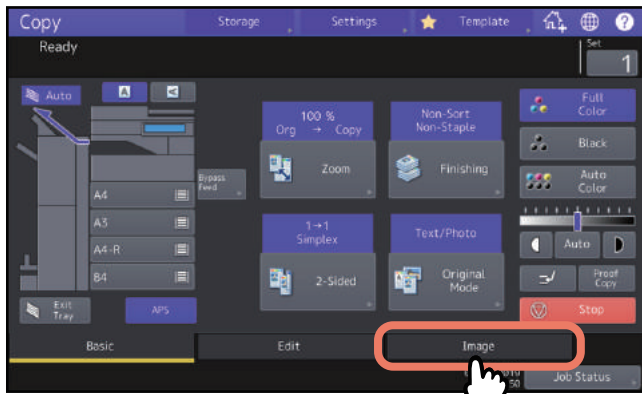

Adjusting Color Balance (CMYK adjustment) (Color Model only)

This function allows you to adjust the overall color balance of the copied image by changing the strength of Yellow (Y), Magenta (M), Cyan (C) and Black (K). This function is available in the full color mode or the auto color mode.

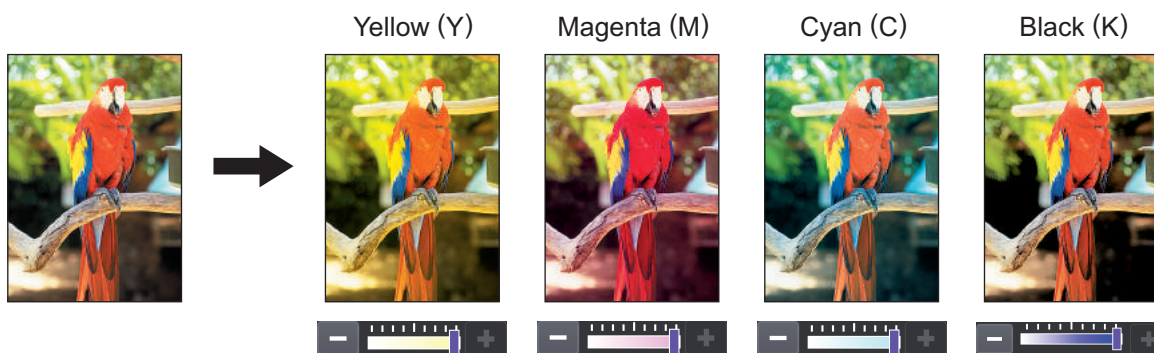

- 1 Press [Color Balance] in the Image menu.
- 2 Press **-** or **+** of each color to obtain the desired color balance.

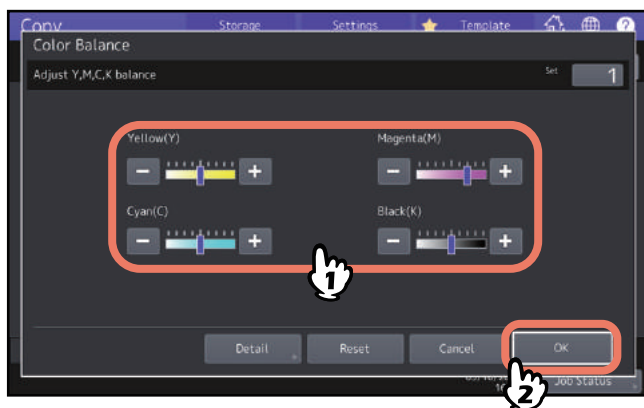

After completing the color balance adjustment, press [OK]. This is the end of the setting. If you want to adjust each color balance on every density area, press [Detail] and go to the next step.

- 3 Press **-** or **+** of the color on each density area to obtain the desired color balance.

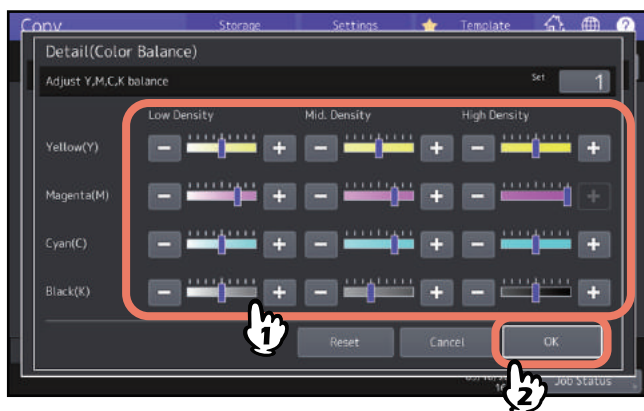

For example, when you adjust the high density area of magenta (M) to the **+** side, the magenta in its high density area becomes darker.

After completing the adjustment, press [OK].

■ Canceling color balance adjustment

- Move the indicator of the color whose adjustment you want to cancel to the middle, and then press [OK].
- If you want to cancel the adjustment of all colors, press [Reset], and then [OK].

Adjusting RGB (Color Model only)

This function allows you to adjust the overall color balance of the copied image by changing the strength of Red (R), Green (G) and Blue (B). This function is available in the full color mode or the auto color mode.

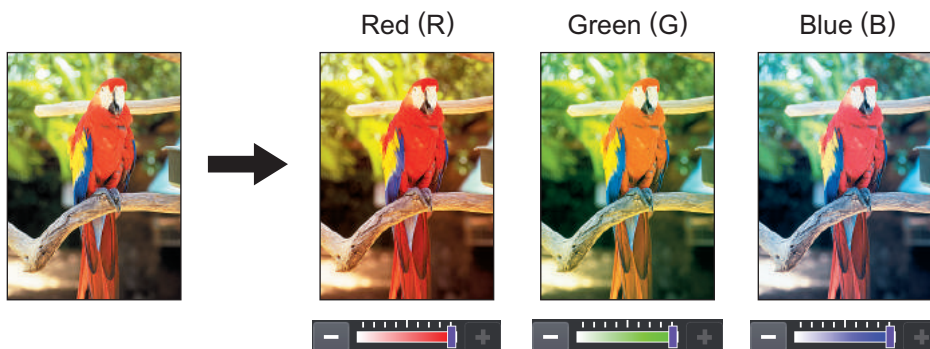

- 1 Press [RGB Adjustment] in the Image menu.
- 2 Press **-** or **+** of the color to obtain the desired color balance, and then press [OK].

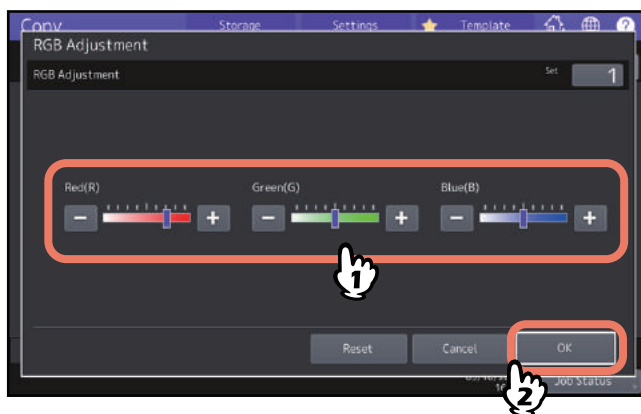

■ Canceling RGB adjustment

- Move the indicator of the color whose adjustment you want to cancel to the middle, and then press [OK].
- If you want to cancel the adjustment of all colors, press [Reset], and then [OK].

Adjusting the Image Quality with One Touch (Color Model only)

This function allows you to obtain the image quality already registered in this equipment. You can select the image quality from “Warm”, “Cool”, “Vivid”, “Clear” and “Marker”. This function is available only in the full color mode.

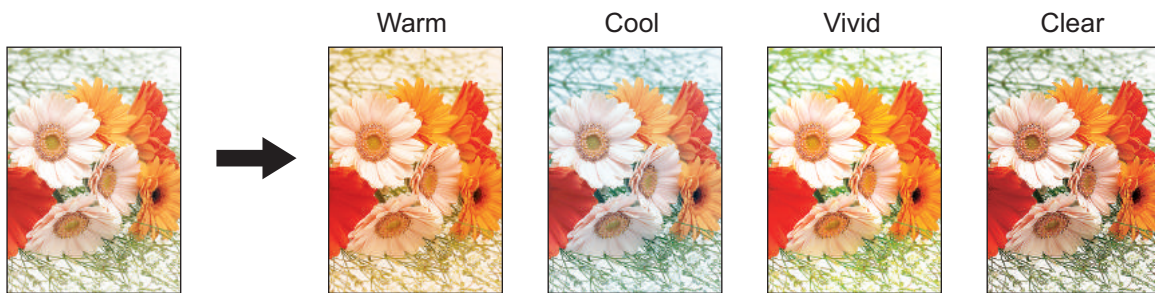

Tip

When [Marker] is selected

Multiple colors drawn with a highlight pen on the original can be copied so as to be distinguished clearly; however, the color shade may not be the same as that of the original depending on the color of the highlight pen.

- 1 Press [One Touch Adjustment] in the Image menu.
- 2 Select the image quality, and then press [OK].

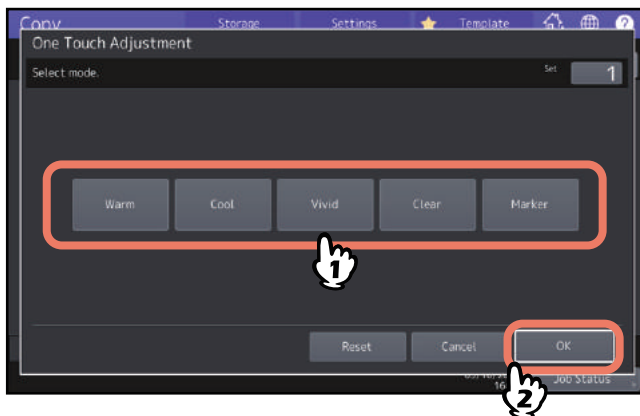

■ Canceling one-touch adjustment

Press [Reset].

Avoiding Bleed-through (Background adjustment)

This function allows you to adjust the density of the original's background. It avoids the back side of a 2-sided original becoming visible on its front side.

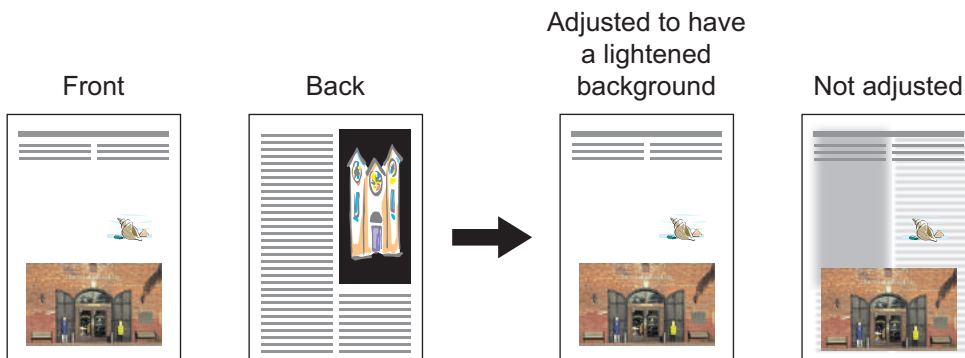

Note

This mode cannot be used with the automatic density adjustment function.
📖 P.42 “Adjusting Density”

- 1 Press [Background Adjustment] in the Image menu.
- 2 Press [Light] or [Dark] to adjust the density, and then press [OK].

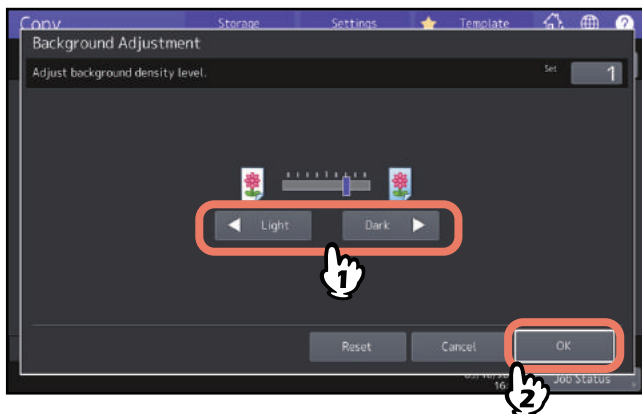

■ Canceling background adjustment

- Move the indicator to the middle, and then press [OK].
- Press [Reset], and then [OK].

Adjusting the Sharpness

This function allows you to emphasize or blur the outline of the image.

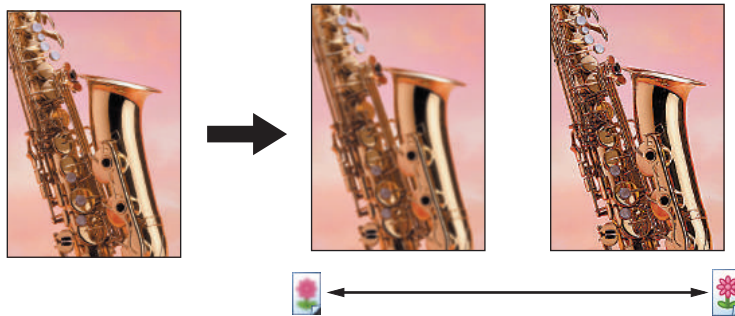

1 Press [Sharpness] in the Image menu.

2 Press [Soft] or [Sharp] to adjust the sharpness, and then press [OK].

When the sharpness level is adjusted to the [Soft] side, the moire fringes on the printed photos, etc. are softened. If it is adjusted to the [Sharp] side, the letters and fine lines become sharper.

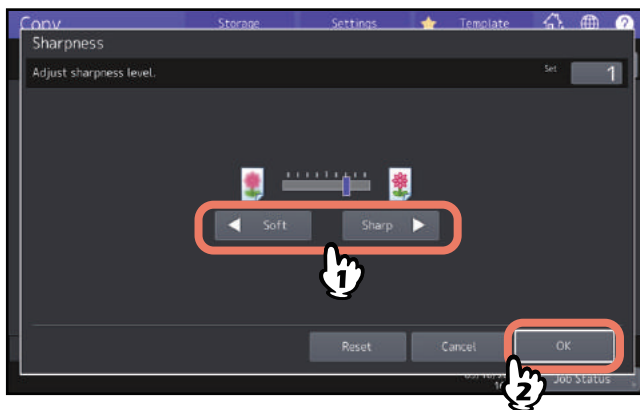

■ Canceling sharpness adjustment

- Move the indicator to the middle, and then press [OK].
- Press [Reset], and then [OK].

Applying Twin Color Copying (Color Model only)

This function allows you to copy a colored original in 2 specified colors. There are 2 types of twin color copying as follows:

- **Twin Color Selectable:** The black part and the parts other than black in the original are copied in 2 specified colors.



- **Red & Black:** The red part in the original is copied in red and the parts other than red are copied in black and white.

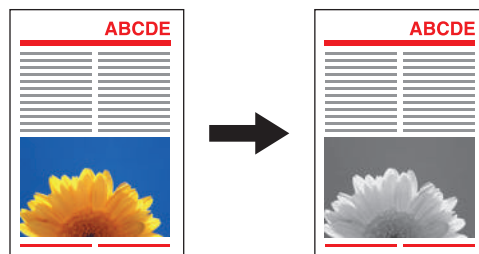

Note

The color may not be correctly reproduced in some originals. In that case, copy them in the full color mode.

■ Copying in black and specified color

1 Press [Twin Color Copy] in the Image menu.

2 Press [Twin Color Selectable].

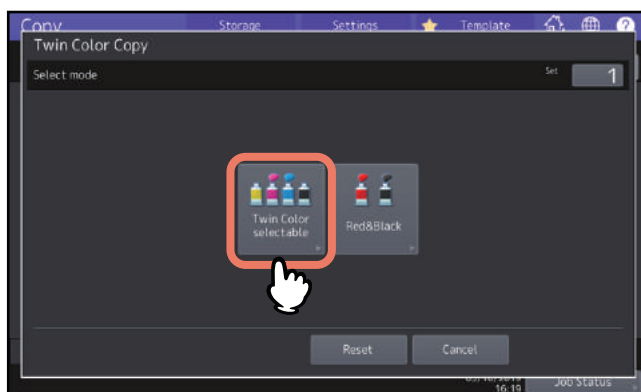

3 Select a color for the black part in the original.

Press [Change Black To], and select the desired color.

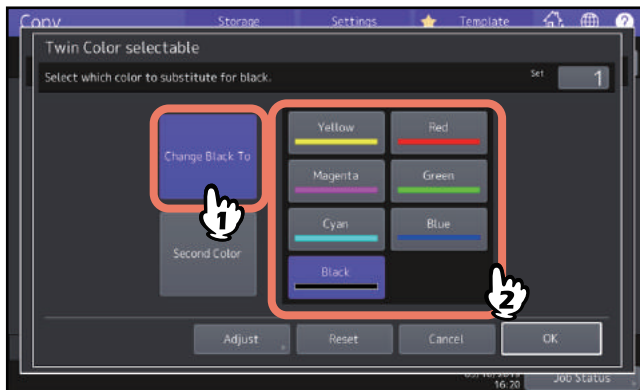

4 Select a color for the parts other than black in the original.

Press [Second Color], and select the desired color.



After selecting the color, press [OK]. This is the end of the setting.
If you want to adjust the color balance, press [Adjust] and go to the next step.

Note

- When the two colors specified are the combination of black and a color other than black, color balance adjustment is enabled. When neither of the two colors is black, or when both of them are black, this adjustment is disabled.
- The color balance of a color other than black can be adjusted.

5 Press **-** or **+** of the color to obtain the desired color balance.

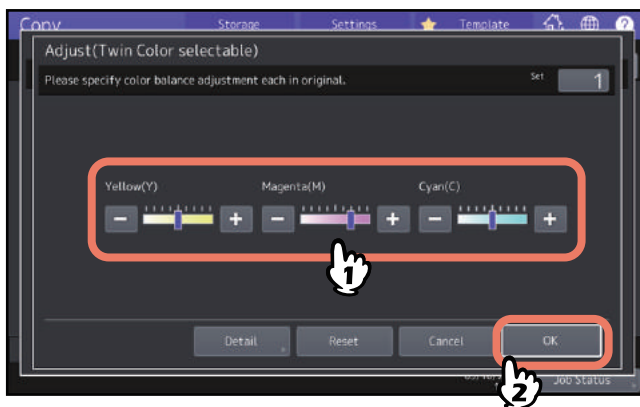

After completing the adjustment, press [OK]. This is the end of the setting.
If you want to adjust each color balance on every density area, press [Detail] and go to the next step.

6 Press **- or **+** of the color on each density area to obtain the desired color balance.**

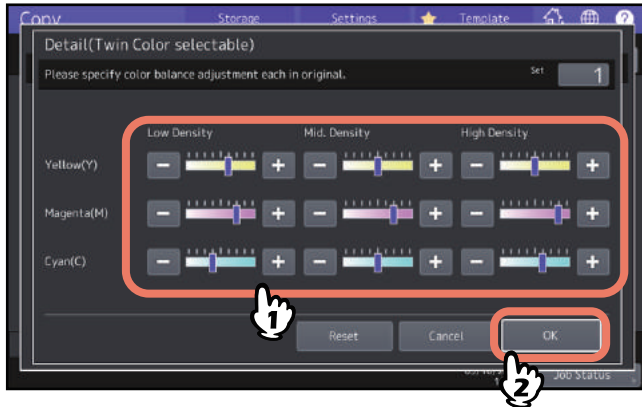

For example, when you adjust the high density area of magenta (M) to the **+** side, the magenta in its high density area becomes darker.

After completing the adjustment, press [OK].

❑ Canceling color balance adjustment

- Move the indicator of the color whose adjustment you want to cancel to the middle, and then press [OK].
- If you want to cancel the adjustment of all colors, press [Reset], and then [OK].

■ Copying in red and black

1 Press [Twin Color Copy] in the Image menu.

2 Press [Red&Black].

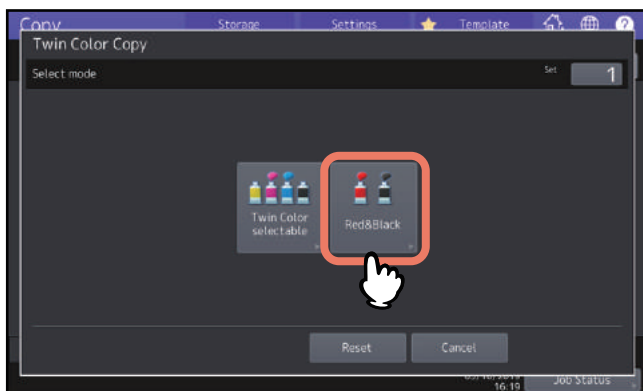

3 To adjust the red color balance or the red-and-black range, press [Adjust]. If you do not want to adjust the color, press [OK].



If you do not adjust the red color balance or the red-and-black range, this is the end of the setting.
If you want to adjust it, go to the next step.

4 Adjust the red color balance or the red-and-black range.

- **Red in original**

Press **−** or **+** of yellow or magenta to adjust the red color balance.

- **Range Adjustment**

Press **◀** or **▶** to adjust the red-and-black range. When you set the red area to be larger, the area to be copied in red becomes larger. When you set the black area to be larger, the area to be copied in black becomes larger.

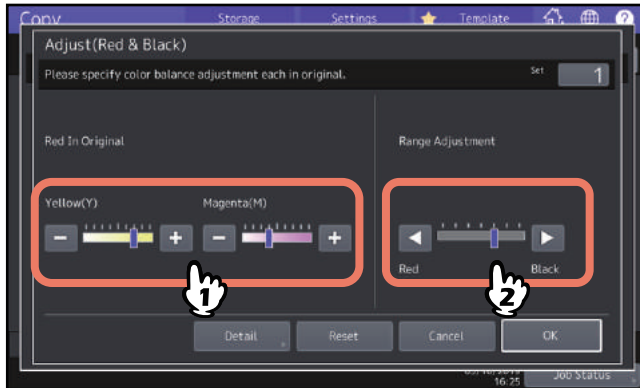

After completing the adjustment, press [OK]. This is the end of the setting.

If you want to adjust color balance of yellow and magenta on every density area, press [Detail] and go to the next step.

5 Press **−** or **+** on each density area to obtain the desired color balance.

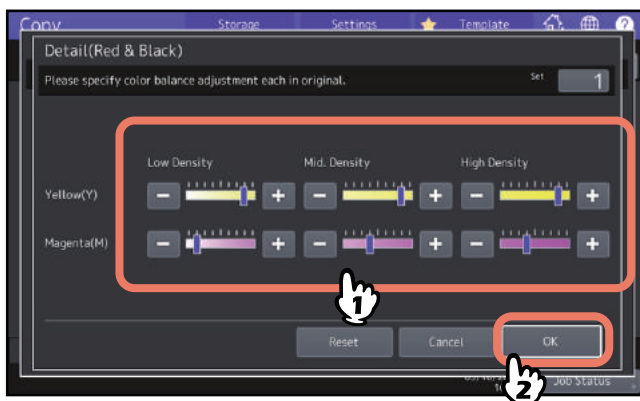

For example, when you adjust the high density area of magenta (M) to the **+** side, the magenta in its high density area will become darker.

After completing the adjustment, press [OK].

❑ **Canceling color balance adjustment**

- Move the indicator of the color whose adjustment you want to cancel to the middle, and then press [OK].
- If you want to cancel the adjustment of all colors, press [Reset], and then [OK].

Applying Mono Color Copying (Color Model only)

This function allows you to make copies in a single color except black. You can select from ten colors.

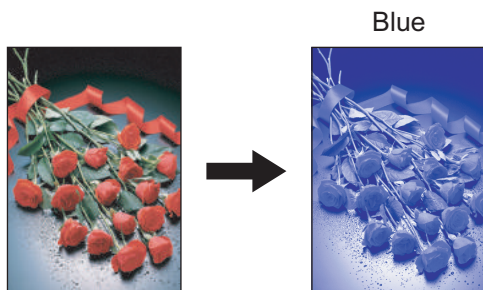

- 1 Press [Mono Color] in the Image menu.
- 2 Press the button corresponding to the desired color.

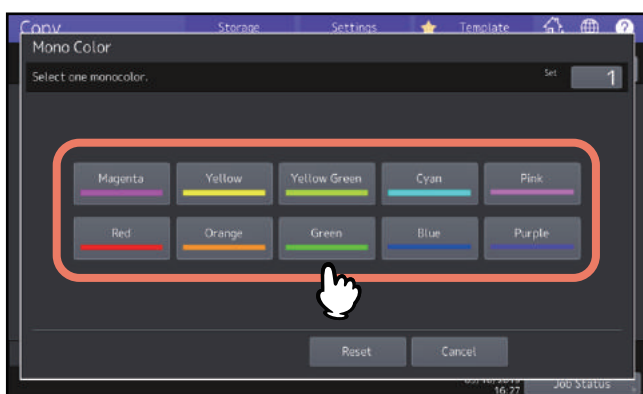

■ Canceling mono color copying

Press [Reset].

Adjusting the Hue (Color Model only)

This function allows you to adjust the hue of the basic color. This function is available in the full color mode or the auto color mode.

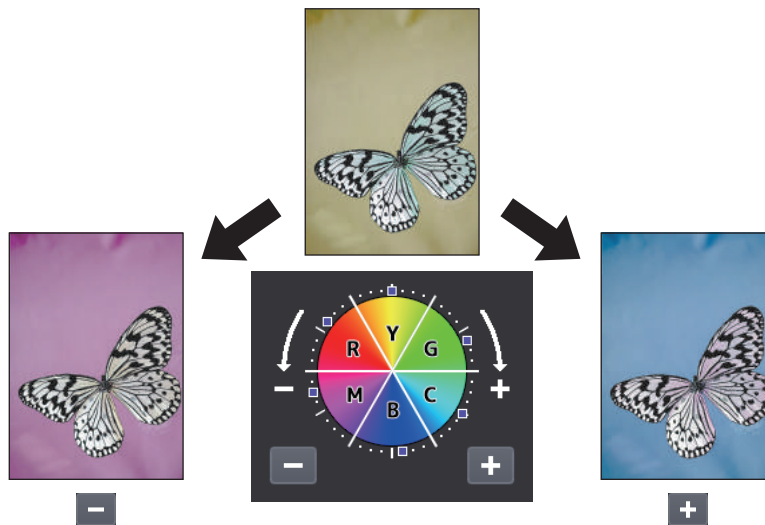

1 Press [Hue] in the Image menu.

2 Adjust the hue.

Adjust the hue of the entire image in section A on the image shown below, and adjust the hue of each basic color in section B. Press **-** or **+** to adjust each option and press [OK].



■ Canceling hue adjustment

- Move the indicator of the color whose adjustment you want to cancel to the middle, and then press [OK].
- If you want to cancel the adjustment of all colors, press [Reset], and then [OK].

Adjusting the Saturation (Color Model only)

This function enables you to adjust the color saturation of the entire image. This function is available in the full color mode or the auto color mode.

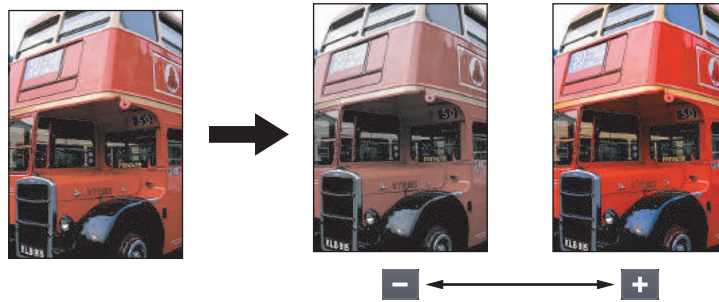

- 1 Press [Saturation] in the Image menu.
- 2 Press **-** or **+** to adjust the saturation, and then press [OK].

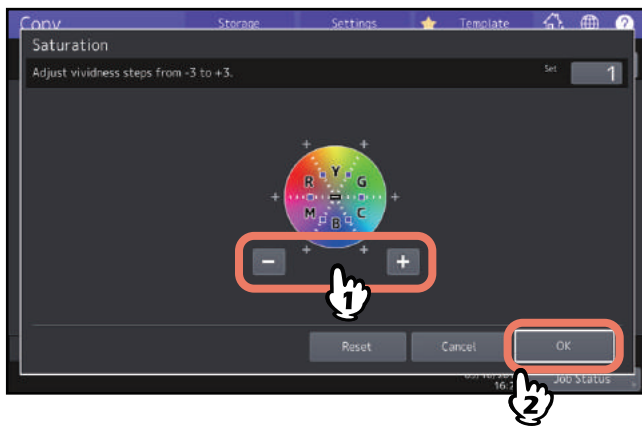

■ Canceling saturation adjustment

- Move the indicator to the middle, and then press [OK].
- Press [Reset], and then [OK].

Reducing the Scan Noise

You can set the scan noise reduction level for scanning originals with the ADF at copying. Scan noise can be reduced if it is conspicuous on images due to fine dust.

1 Press [ADF Noise Reduction] in the Image menu.

2 Press [Low], [Middle], or [High] to adjust the scan noise reduction level, and then press [OK].

Tip

Fine lines other than scan noise may become faint if you set the scan noise reduction level higher.

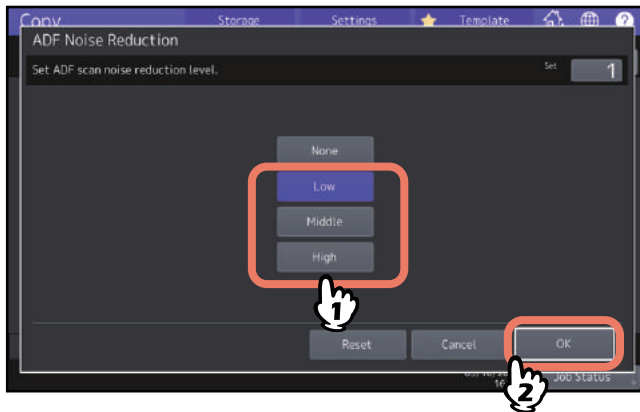

■ Canceling the ADF scan noise reduction

Press [None] or [Reset], and then [OK].

Copying black images only (Color Model only)

This function enables you to carry out copying of only the black images in an original, while those images with other colors are removed.

Tip

Depending on the colors used in an original, they are sometimes not able to be removed properly.

- 1** Select the [Basic] tab, and then [Black] in the color mode.
- 2** Press [Drop Out Color] in the image menu.
- 3** If necessary, adjust the remove range in [Drop Out Level Adjustment], and then press [OK].
 - “+”: Makes the remove range larger. (Colors which are close to black will become easier to remove.)
 - “-”: Makes the remove range smaller. (Colors which are close to black will become easier to remain.)

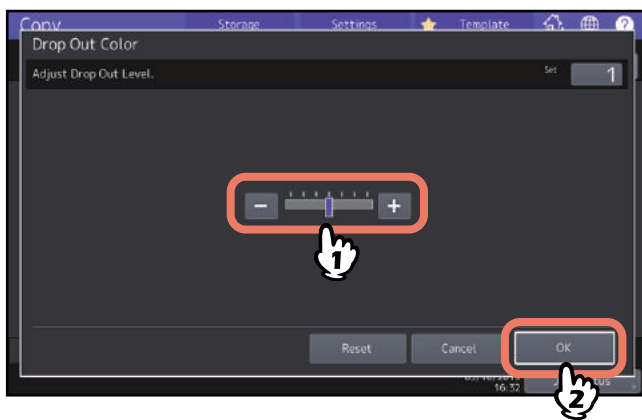

SAVING COPIED DATA AS A FILE

This chapter explains additional features used in making copies, including enlargement and reduction copying, finishing mode, and duplex copying.

Copying and Saving as a File	124
Setting share folder	126

Copying and Saving as a File

With the Copy & File function, you can store the copied data in the share folder of the internal storage device of this equipment or a specified PC on a network. The data can be stored in any of PDF, TIFF and XPS formats.

Note

- The data will be stored as black images. (Resolution: 600 dpi only) The data stored with this function are suited for printing but not for being imported as an image into your PC. To obtain the optimal image quality for importing, it is recommended to store the data with the Scan to File function of this equipment.
- The network administrator must make settings for Copy & File in advance. For details, refer to the **TopAccess Guide**.
- It is recommended to back up the data stored in the share folder.

Tip

You can store data in an e-Filing box with the Store to e-Filing function. For details, refer to the **e-Filing Guide**.

1 Press [Storage] on the touch panel.

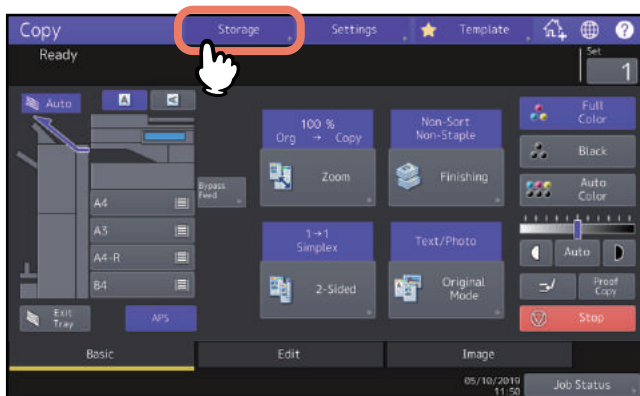

2 Press [Copy & File] on the touch panel.

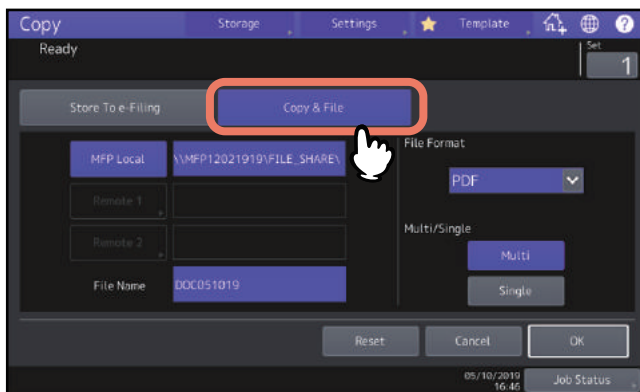

3 Enter file information and press [OK].

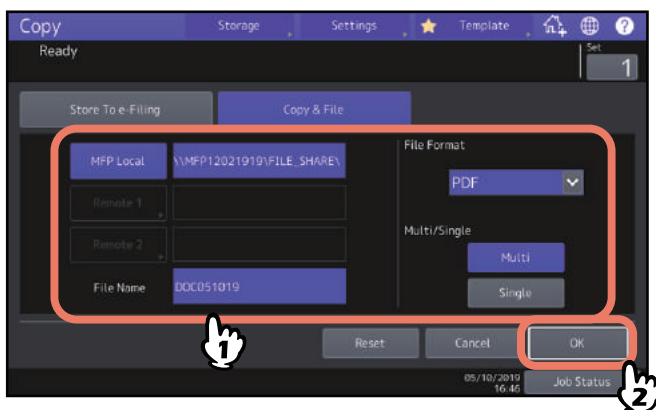

- **MFP Local:** Press this to store the data into the share folder of this equipment.
- **Remote 1, Remote 2:** Press either of them to store the data into the share folder of a PC that is connected with this equipment via a network.
- **File Name:** Then enter the file name within 128 letters.
- **File Format:** Select the file format in which the data are stored from PDF, TIFF or XPS.
- **Multi / Single:** If you select [Multi], all the scanned data will be stored as one file. If you select [Single], a folder is created and each page of the scanned data will be stored individually as one file in the folder.

Note

- You can select up to 2 of [MFP Local], [Remote 1] and [Remote 2]. You can cancel the selected item by pressing the same button again.
- When a user who has the privilege of changing the setting of [Remote 1] and [Remote 2] has pressed either of them, the menu for specifying a directory appears. In this case, see the following page to specify the directory:
 P.126 “Setting share folder”
- The trailing characters in a file name (maximum 74) may be deleted depending on the type of letters used.

4 Press the [START] button on the control panel.

When the original is placed on the ADF, copying and storing start simultaneously.
 When the original is placed on the original glass, follow the procedure below.

5 Place the next original on the original glass, and then press [Next Copy] on the touch panel or the [START] button on the control panel.

Repeat this step until the scanning of all the originals is finished.

6 When all have been scanned, press [Job Finish] on the touch panel.

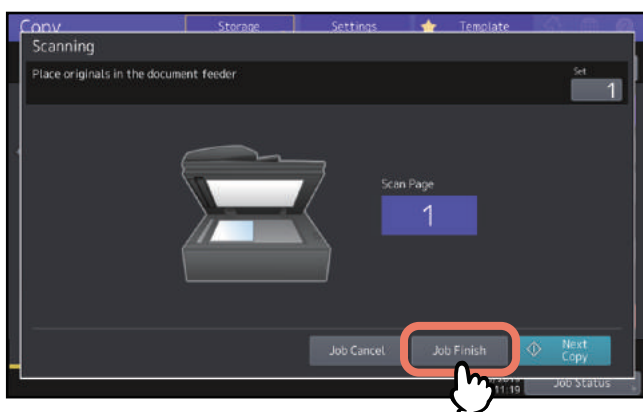

Copying and storing start.

■ Setting share folder

When a user who has the privilege of setting a share folder has pressed [Remote 1] or [Remote 2], the menu for specifying a directory appears.

The setting items differ depending on the file transfer protocol to be used. FTP, SMB, NetWare IPX/SPX, NetWare TCP/IP and FTPS are selectable for a file transfer protocol.

□ FTP / FTPS

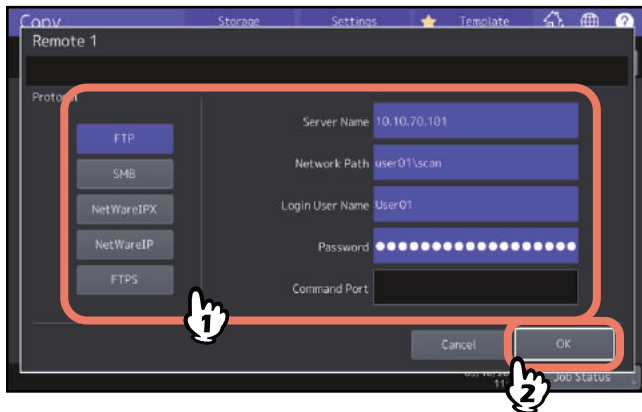

When you press any of the buttons below, the on-screen keyboard appears. When you finish the entry, press [OK].

- **Server Name:** Press this to enter the IP address of FTP server. For example, if the data should be transferred to an FTP folder ftp://10.10.70.101/user01/scan/, key in “10.10.70.101”.
- **Network Path:** Press this to enter a network path to an FTP folder where the data are to be stored. For example, if the data should be transferred to an FTP folder ftp://10.10.70.101/user01/scan/, enter “user01\scan”.
- **Login User Name:** Press this to enter a user name to login to the FTP server. Enter this as required.
- **Password:** Press this to enter a password to login to the FTP server. Enter this as required.
- **Command Port:** Press this to key in a command port number for executing commands. Normally “-” is entered in this field, which means that a port number set by the administrator will be used. Change this only when you want to use any other port number.

□ SMB

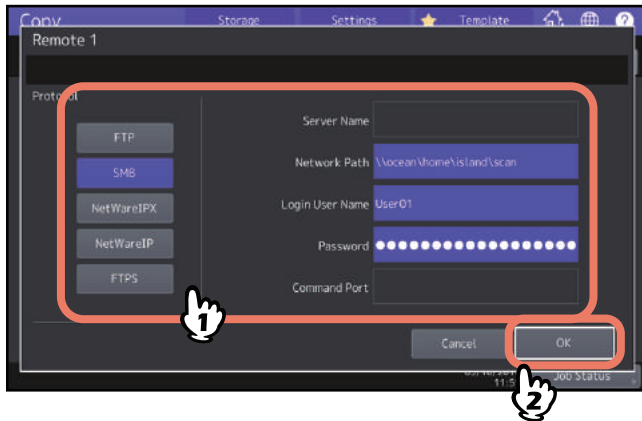

When you press any of the buttons below, the on-screen keyboard appears. When you finish the entry, press [OK].

- **Network Path:** Press this to enter a network path to the folder where the data are to be stored.
- **Login User Name:** Press this to enter a user name to access the network folder. Enter this as required.
- **Password:** Press this to enter a password to access the network folder. Enter this as required.

Tip

If you selected [SMB], the settings for [Server Name] and [Command Port] are not required.

□ NetWareIPX / NetWareIP

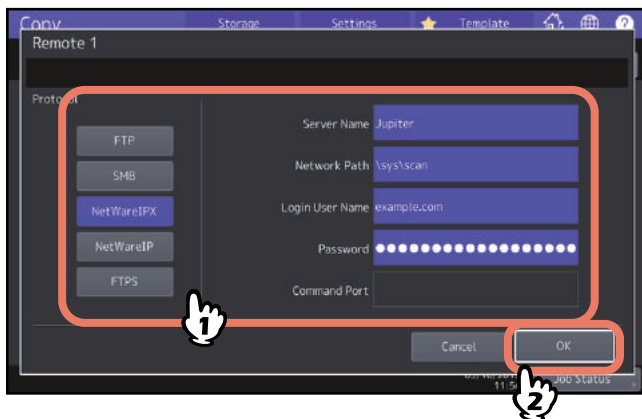

When you press any of the buttons below, the on-screen keyboard appears. When you finish the entry, press [OK].

- **Server Name:** When you select [NetWareIPX], enter either the server name of NetWare server or Tree/Context (if NDS is usable). When you select [NetWareIP], enter the IP address of NetWare server.
- **Network Path:** Press this to enter a network path to a NetWare server folder where the data are to be stored. For example, if the data should be transferred to a folder “sys\scan” of NetWare server, enter “\sys\scan”.
- **Login User Name:** Press this to enter a user name to login NetWare server. Enter this as required.
- **Password:** Press this to enter a password to login NetWare server. Enter this as required.

INDEX

Numerics

2 in1 / 4 in1	74
[2-Sided]	11

A

A/B format	4
ADF	4
ADF (Continuous feed mode)	102
ADF -> SADF	102
ADF Scan Noise Reduction	120
Alert message indication area	11
AMS (Automatic Magnification Selection)	44
[APS]	11, 27
APS (Automatic Paper Selection)	27
Auto Color	41
Auto job start	23
Automatic Magnification Selection (AMS)	44
Automatic Paper Selection (APS)	15, 27

B

Background Adjustment	110
Basic menu	11
[Basic] tab	11
Black	41
Book Center Erase	93
Bypass copying	
bypass copying	32
envelope	37
non-standard size paper	38
standard size paper	33
[Bypass Feed]	14
Bypass tray	33, 35, 37, 38

C

Center fold	54, 58
Clearing the set functions	17
CMYK adjustment	107
Color Balance	107
Color mode	
Auto Color	41
Black	41
color mode	15, 41
Full Color	41
Color mode buttons	12
Confirmation screen	16
Copy & File	124
Copy quantity	15

Copying

auto job start	23
basic procedure	21
book-type originals	65
bypass copying	32
copy & file	124
copy quantity	15
duplex copying	62
envelope	37
important information	10
interrupting	24
mixed-size originals	29
non-standard size paper	38
number of copies	21
photo originals	49
proof copy	25
reproduction ratio	15, 43
restarting	23
stopping	23
Copying functions	
before using copier functions	15
clearing the set functions	17
confirming the set functions	16
Cover Sheet	77

D

Default settings	15
Density adjustment	15, 42
Density adjustment buttons	12
Department management function	13
Drawer buttons	13
[Drop Out Color]	121
Dual Page	95
Duplex copying	
1-sided original -> 1-sided copy	62
1-sided original -> 2-sided copy	62
2-sided original -> 1-sided copy	62
2-sided original -> 2-sided copy	62
book-type original -> 2-sided copy	62
simplex/duplex setting	62

E

Edge Erase	92
Edit menu	70
[Edit] tab	11
Editing	84
masking	84
mirror image	87
negative/positive reversal	87
trimming	84

Editing functions.....	69	I	
2 in1 / 4 in1	74	Image adjustment functions.....	105
ADF -> SADF.....	102	ADF Scan Noise Reduction	120
Book Center Erase	93	Background Adjustment.....	110
Cover Sheet.....	77	Color Balance	107
Dual Page.....	95	Hue.....	118
Edge Erase.....	92	Mono Color	117
Editing.....	84	One Touch Adjustment.....	109
Full Image.....	52	RGB Adjustment.....	108
Image Repeat.....	89	Saturation	119
Image Shift.....	71	Sharpness.....	111
Job Build	99	Twin Color Copy.....	112
Omit Blank Page	91	Image menu	106
Outside Erase	97	Image Repeat.....	89
Page Number	83	Image Shift.....	71
Sheet Insertion	79	Image Smoothing.....	68
Time Stamp.....	82	[IMAGE] tab	11
XY Zoom	88	[Image] tab	106
Envelope.....	37	[Interrupt]	24
Equipment status indication area.....	11, 13	Interrupt copying	12
[Exit Tray]	13	Interrupting copying	24
F		J	
[Finishing].....	11	Job Build	99
Finishing mode		[Job Status]	12
center fold	54, 58	L	
finishing mode	15	LT format	4
group	54, 55	M	
hole punch	54, 61	Magazine sort	54, 58
magazine sort	54, 58	Magazine sort & center fold	54, 58
magazine sort & center fold	54, 58	Magazine sort & saddle stitch	54, 58
magazine sort & saddle stitch	54, 58	Manual staple	54
manual staple	54	Map.....	68
non-sort non-staple.....	54	Message indication area	11
rotate sort	54, 56	Mono Color	117
saddle stitch.....	54, 58	N	
selecting.....	54	NetWareIP.....	127
sort	54, 55	NetWareIPX.....	127
staple sort	54, 57	Non-sort Non-staple.....	54
FTP	126	Number of copies	12, 21
FTPS.....	126	Number of remaining copy sets.....	12
Full Color	41	O	
Full Image.....	52	OHP film.....	32, 34
[FUNCTION CLEAR] button	15, 17, 32	Omit Blank Page.....	91
G		One Touch Adjustment	109
Group.....	54, 55	[Original Mode].....	11, 68
H		Original mode	
Help button	12	Image Smoothing.....	68
Hole punch	54, 61	Map	68
Hue.....	118	original mode	15, 68
		Photo	68
		Printed Image.....	68
		Text.....	68
		Text/Photo	68
		Originals	
		mixed-size originals	29
		Outside Erase.....	97

P	
Page Number.....	83
Paper	
amount of paper remaining.....	13
paper type setting	31, 33, 36
specifying the paper size.....	27
Paper selection	15
Paper type on the bypass tray.....	14
Paper type setting.....	31, 33, 36
Photo	68
Photo Zoom.....	49
Printed Image.....	68
[Proof Copy]	12
Proof copy	25
R	
Receiving tray indication	13
Receiving tray selection.....	40
Reproduction ratio.....	15, 43
RGB Adjustment	108
Rotate sort.....	54, 56
S	
Saddle stitch.....	54, 58
SADF.....	102
Saturation.....	119
[Settings]	12
Share folder	126
Sharpness.....	111
Sheet Insertion	79
Simple Copy	10
Simplex/duplex setting.....	15
Single feed mode	102
SMB.....	127
Sort	54, 55
Specifying the paper size.....	27
Staple sort	54, 57
[START] button.....	21, 23
Sticker labels.....	32
[Stop] button.....	23
[Storage].....	12
Storage of color copies	10
T	
[Template].....	12
Text	68
Text/Photo.....	68
Time Stamp	82
Touch panel.....	11
Twin Color Copy	112
U	
User management function.....	13
X	
XY Zoom.....	88
Z	
[Zoom]	11, 44

e-STUDIO2010AC/2510AC
e-STUDIO2515AC/3015AC/3515AC/4515AC/5015AC
e-STUDIO2518A/3018A/3518A/4518A/5018A
e-STUDIO5516AC/6516AC/7516AC
e-STUDIO5518A/6518A/7518A/8518A

**MULTIFUNCTIONAL DIGITAL COLOR SYSTEMS /
MULTIFUNCTIONAL DIGITAL SYSTEMS**

Copying Guide

e-STUDIO2010AC/2510AC

e-STUDIO2515AC/3015AC/3515AC/4515AC/5015AC

e-STUDIO2518A/3018A/3518A/4518A/5018A

e-STUDIO5516AC/6516AC/7516AC

e-STUDIO5518A/6518A/7518A/8518A

TOSHIBA TEC CORPORATION

1-11-1, OSAKI, SHINAGAWA-KU, TOKYO, 141-8562, JAPAN